

**PROUD AMERICAN MANUFACTURER**

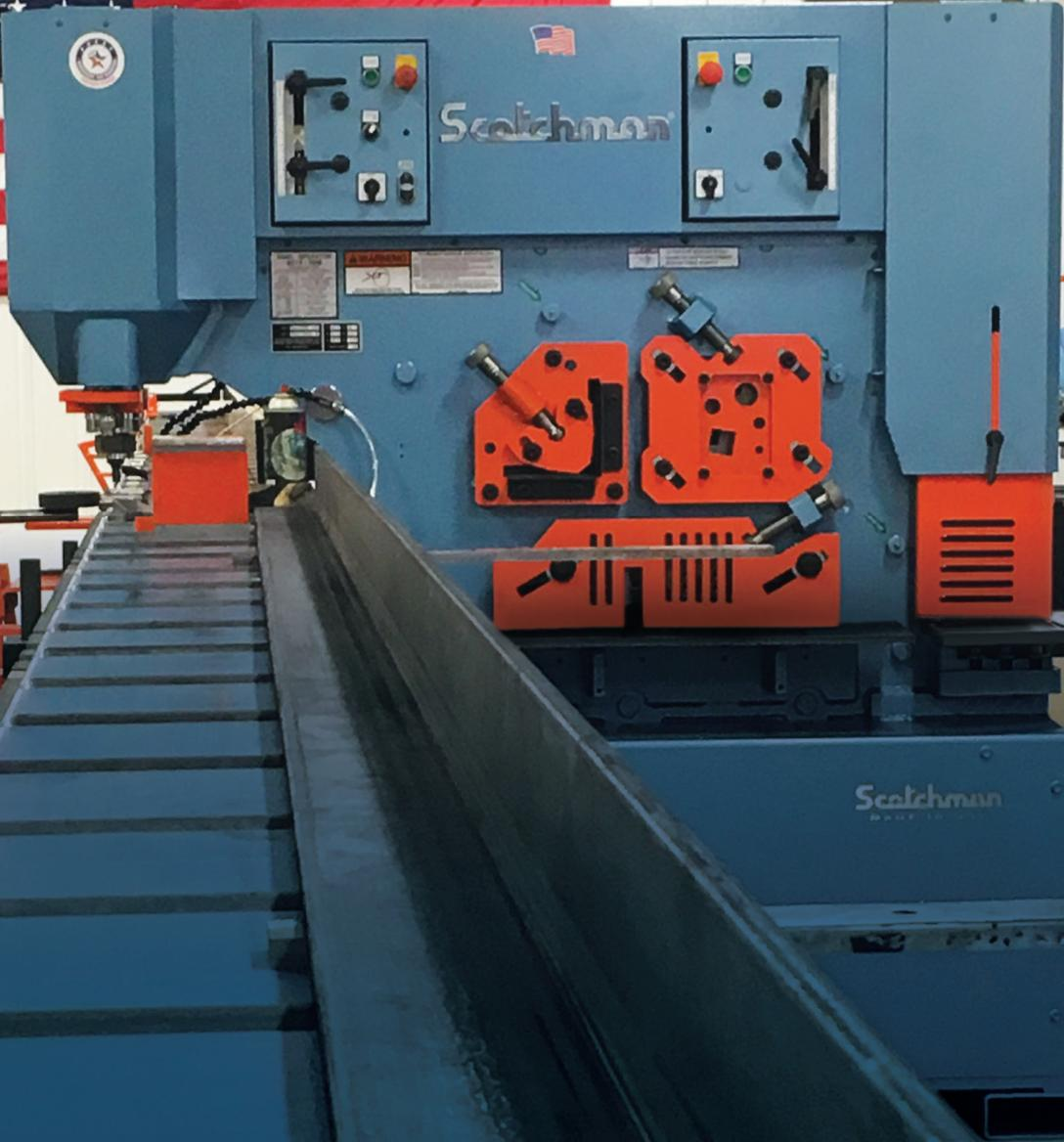

# Scotchman<sup>®</sup>

Metal Fabricating Solutions

*Ironworkers | Cold Saws | Automatic Sawing Systems | Hydraulic Press | Pipe Notchers | Measuring Devices*

2024

# Scotchman®



## AMERICAN MANUFACTURER

Scotchman Industries, established in 1967, is a leading provider of steel fabrication equipment and is the oldest and largest manufacturer of hydraulic ironworkers. Located in Philip, South Dakota, we take pride in manufacturing USA made metal fabricating machinery that can be passed down from generation to generation.

Our company was founded on the principle of providing well-built machinery to help our

customers find efficient solutions for their shop needs. We remain committed to building high-quality & dependable USA made products, providing first-class customer service, and have confidence in the strength of American manufacturing.

We believe that developing interest in manufacturing among our Nation's youth is vital to the future of American manufacturing and we fully support shop class education and trade schools with educational discounts and other programs.

When you buy a Scotchman machine, you'll have peace of mind knowing you're supporting an American company who supports the community.

# Table of Contents



Scotchman Industries is also proud to support Workshops For Warriors®, a non-profit with a mission to train, certify, and help place Veterans, Wounded Warriors, and Transitioning Service Members into advanced manufacturing careers. Scotchman is thankful for all veterans and current USA military personnel and grateful for their service to our country. Let's rebuild American manufacturing together!



|                                |              |
|--------------------------------|--------------|
| <b>IRONWORKERS</b> .....       | <b>3-25</b>  |
| <b>BAND SAW</b> .....          | <b>26</b>    |
| <b>COLD SAWS</b> .....         | <b>27-42</b> |
| <b>MEASURING DEVICES</b> ..... | <b>43-46</b> |

|                                |              |
|--------------------------------|--------------|
| <b>PIPE NOTCHERS</b> .....     | <b>47-50</b> |
| <b>HYDRAULIC PRESSES</b> ..... | <b>51-52</b> |
| <b>CUSTOMER SERVICE</b> .....  | <b>53</b>    |
| <b>FINANCING</b> .....         | <b>54</b>    |

# Ironworkers

IRONWORKERS

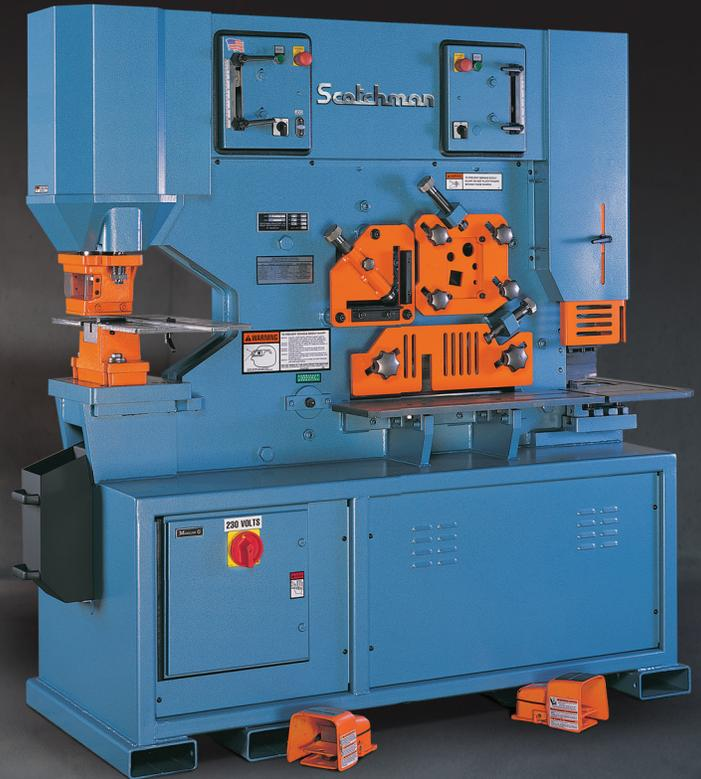
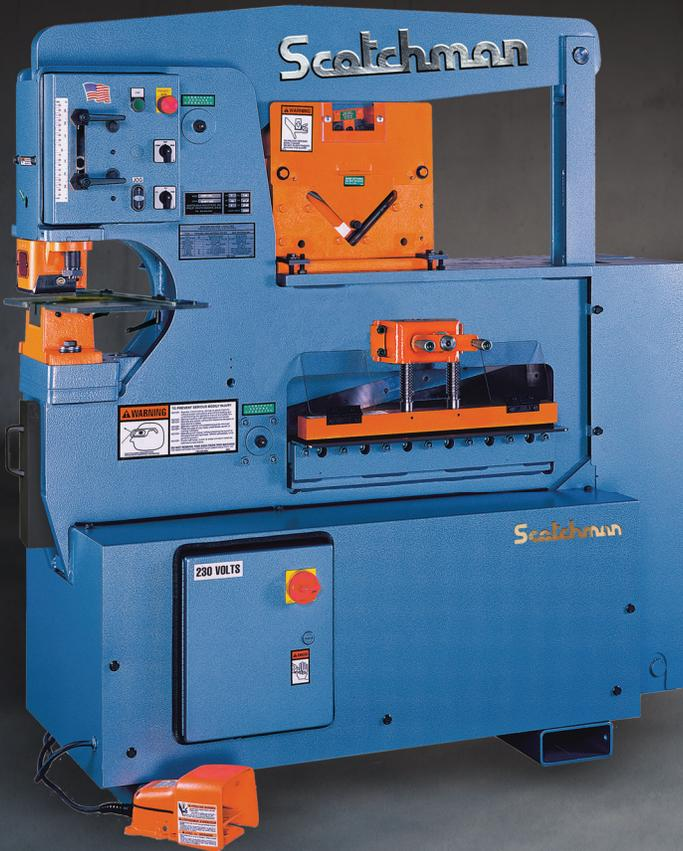

## Single & Dual Operator Hydraulic Ironworkers

**American Made with 3-Year Warranty**

Backed by the Scotchman reputation of superior quality and dependability, our ironworkers are built tough to last generations. Models range in capacity from 45-150 tons and are available in two distinct styles.

- Our unique Component Tool Table style provides flexibility to swap-out tooling quickly for those quick turnaround jobs. The variety of tooling options available for this style provides greater versatility than any other machine on the market.
- Our fully-Integrated Ironworkers featuring built-in tools are best suited for repetitive, higher volume projects.

### CAPACITY CHART QUICK REFERENCE GUIDE... 5-6

|                             |       |
|-----------------------------|-------|
| 45 TON .....                | 5-6   |
| 50 TON .....                | 7-8   |
| 50 TON .....                | 9-10  |
| 65 TON .....                | 11    |
| 70 TON .....                | 12    |
| 85 TON .....                | 13-14 |
| 90 TON .....                | 15    |
| 95 TON .....                | 16    |
| 120 TON .....               | 17-18 |
| 135 TON .....               | 19    |
| 150 TON .....               | 20    |
| OPTIONAL TOOLING .....      | 21-22 |
| CUSTOM TOOLING .....        | 23    |
| IN-STOCK PUNCH & DIES ..... | 24    |
| PRODUCTION SHEAR .....      | 25    |



# Component Tool Style Workstations

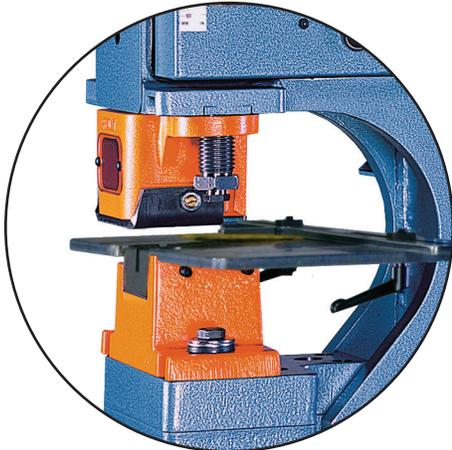

## **PUNCH:**

The punch station is one of the most functional standard tools on any ironworker. A full range of punches & dies in standard shapes and increments are available in-stock for your various punching needs, plus tooling can be custom built for your special application. This workstation can also be used for additional applications beyond strictly punching.

## **FLAT BAR SHEAR:**

A flat bar shear is a standard workstation on all ironworkers, but not all bar shears are created equal. All Scotchman ironworkers have a shear with a variable rake angle which minimizes distortion of the cut and increases cut time for a faster shear cycle. From 6" to 24" in width, each Scotchman ironworker is equipped with the best shear for its capacity. Hold-downs are easily adjustable with good visibility, and the reversible shear blades provide a long life of plate shearing.

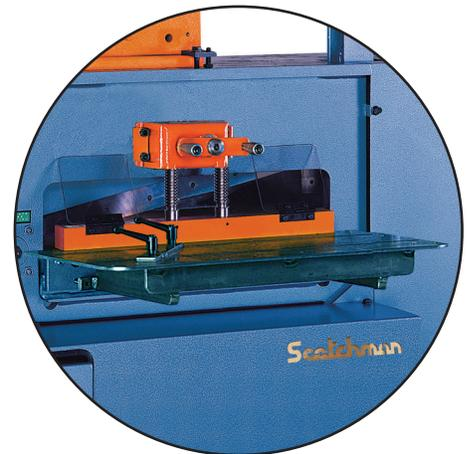

## **ANGLE SHEAR:**

This useful tool is standard on every Scotchman ironworker. Produces a distortion free cut, and can easily & quickly 45° miter cut.



## **NOTCHER:**

Ideal for notching and nibbling of plate and angle iron. When versatility is key, a copier notcher is essential. Standard workstation on most Scotchman ironworker models, but available as an option on the models it is not standard.

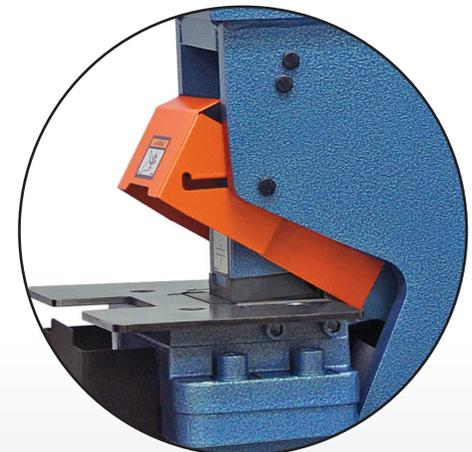

## **TOOL TABLE WORKSTATION FOR COMPONENT TOOLS:**

When versatility and flexibility are key, our unique tool table workstation is indispensable! This tool table design is unique to Scotchman and creates a workstation that is fully customizable allowing an extensive variety of different tooling options to be used and switched out easily, without losing the punch station. This workstation acts as an additional power source which allows users to tailor the machine to their individual needs.



Scotchman has a variety of tooling options available as well as a full-time custom tooling department making the options nearly endless.

# Ironworker Capacities

IRONWORKERS

|   |                   | 45 ton  | 50 ton  | 50 ton  | 65 ton   | 70 ton  | 85 ton  |
|---|-------------------|---|---|---|--|---|---|
|   |                   | Single Operator   | Single Operator   | Single Operator   | Single Operator  | Dual Operator   | Single Operator   |
| Machine Design Style  |                   | Component Tool Table  | Component Tool Table  | Component Tool Table  | Component Tool Table   | Component Tool Table  | Fully Integrated Tools  |
| Punch   | Throat Depth      | 4-1/4"  | 6"  | 4"  | 9"   | 9"  | 10"   |
|   | Tonnage           | 45 ton  | 50 ton  | 50 ton  | 65 ton   | 70 ton  | 85 ton  |
|   | Capacity          | 1-1/8" in 1/2"  | 1-1/4" in 1/2"<br>13/16" in 3/4"  | 1-1/4" in 1/2"<br>13/16" in 3/4"  | 1-1/16" in 3/4"  | 1-1/8" in 3/4"  | 1-1/16" in 1"   |
|   | Max. Hole         | 2-1/4"  | 2-1/4"  | 2-1/4"  | 4"   | 4"  | 4"  |
| Bar Shear   | Blade Length      | 6"  | 14"   | 14"   | 24"  | 24"   | 20"   |
|   | Max. Capacity     | 1/2" x 4"   | 3/4" x 4"   | 3/4" x 4"   | 1" x 6"  | 1" x 6"   | 1" x 12"  |
|   |                   | 3/8" x 6"   | 1/2" x 8"<br>3/8" x 10"<br>1/4" x 14"   | 1/2" x 8"<br>3/8" x 10"<br>1/4" x 14"   | 3/4" x 10"<br>1/2" x 12"<br>3/8" x 16"<br>1/4" x 24"                                 | 3/4" x 10"<br>1/2" x 14"<br>3/8" x 24"  | 3/4" x 20"  |
| Angle Shear   | Angle Shear, 90°  | 3" x 3" x 5/16"   | 4" x 4" x 3/8"  | 4" x 4" x 3/8"  | 6" x 6" x 3/8"<br>5" x 5" x 1/2"   | 6" x 6" x 1/2"  | 6" x 6" x 1/2"  |
|   | Angle Shear, 45°  | 2" x 2" x 1/4"  | 2" x 2" x 1/4"  | 2" x 2" x 1/4"  | 3" x 3" x 3/8"<br>4" x 4" x 1/2" (with bar shear)                                    | 3" x 3" x 3/8"<br>4" x 4" x 1/2" (with bar shear)                                     | 4" x 4" x 1/2" (with bar shear)   |
| Channel Shear   | Size Avail.       | up to 3"  | up to 3"  | up to 3"  | 2" to 5" adjustable  | 2" to 6" adjustable   | 2" to 6" adjustable   |
| Rod Shear   | Round Rod         | 1/4" to 1", 5 cavity  | 1/4" to 1", 5 cavity  | 1/4" to 1", 5 cavity  | 1/4" to 1-1/4", 9 cavity   | 1/4" to 1-1/4", 9 cavity  | 1-1/2", 1 cavity  |
|   | Square Rod        | 1/4" to 3/4", 1 cavity  | 1/4" to 3/4", 1 cavity  | 1/4" to 3/4", 1 cavity  | 1/4" to 1", 1 cavity   | 1/4" to 1", 1 cavity  | 1-1/4", 1 cavity  |
| Tube Shear  | Square Tube       | 1/2" to 1", 12 gauge  | 1/2" to 1", 12 gauge  | 1/2" to 1", 12 gauge  | 1/2" to 2", 12 gauge   | 1/2" to 2", 12 gauge  | 1/2" to 2", 12 gauge  |
| Notcher   | Rectangle         | 2" x 1-3/4" x 1/4"  | 2-1/2" x 3" x 5/16"<br>2-1/2" x 2-3/4" x 3/8"                                       | 2-1/2" x 3" x 5/16"<br>2-1/2" x 2-3/4" x 3/8"                                       | 2" x 2-1/2" x 3/8"   | 3" x 5" x 3/8"<br>3" x 4" x 1/2"  | 3" x 5" x 1/2"  |
|   | 90° V             | 6" x 6" x 1/8"  | 6" x 6" x 1/8"<br>3" x 3" x 1/4"  | 6" x 6" x 1/8"<br>3" x 3" x 1/4"  | 6" x 6" x 5/16"  | 6" x 6" x 5/16"   | 6" x 6" x 5/16" (Punch Station)   |
|   | Pipe (Sch. 40)    | 3/4" to 2"  | 3/4" to 2"  | 3/4" to 2"  | 3/4" to 2"   | 3/4" to 2"  | 3/4" to 2"  |
| Bending   | Brake Size Avail. | 6", 8", 12", 6" Open-End  | 6", 8", 12", 6" Open-End  | 6", 8", 12", 6" Open-End  | 12", 24", 6" Open-End  | 12", 24", 6" Open-End   | 12", 24", 6" Open-End   |
| Picket Tool   | Size              | 1/2", 3/4", & 1" (16 gauge)   | 1/2", 3/4", & 1" (16 gauge)   | 1/2", 3/4", & 1" (16 gauge)   | 1/2", 3/4", & 1" (16 gauge)  | 1/2", 3/4", & 1" (16 gauge)   | 1/2", 3/4", & 1" (16 gauge)   |
| Motor   | Standard          | 110v  | 230/460v, 3 ph  | 230/460v, 3 ph  | 230/460v, 3 ph   | 230/460v, 3 ph  | 230/460v, 3 ph  |
|   | Optional          | 220v, 1 ph  | 220v, 1 ph  | 220v, 1 ph  | 220v, 1 ph   | 220v, 1 ph  | 220v, 1 ph  |
| <p>*Not all functions &amp; capacities are standard, but can be achieved with optional tooling.</p> <p>*Custom built tooling is available upon request.</p> |                   |  |  |  |  |  |  |
| Model Name  |                   | Porta Fab 45  | 50514-EC  | 5014-ET   | 6509   | DO 70   | FI 85   |
|   |                   | Page 7  | Page 9  | Page 9  | Page 11  | Page 12   | Page 13   |

# Quick Reference Guide

IRONWORKERS

| 85 ton  |  | 90 ton  |  | 95 ton  |  | 120 ton   |  | 120 ton   |  | 135 ton  |  | 150 ton   |  | Production Shear  |  |                                      |  |
|---|--|---|--|---|--|---|--|---|--|--|--|---|--|---|--|--------------------------------------|--|
| Dual Operator   |  | Single Operator   |  | Dual Operator   |  | Single Operator   |  | Dual Operator   |  | Dual Operator  |  | Dual Operator   |  | Single Operator   |  |                                      |  |
| Fully Integrated Tools  |  | Component Tool Table  |  | Component Tool Table  |  | Component Tool Table  |  | Component Tool Table  |  | Component Tool Table   |  | Component Tool Table  |  | Shear Only  |  |                                      |  |
| 14"   |  | 12"   |  | 9"  |  | 12"   |  | 12"   |  | 12"  |  | 12"   |  | N/A   |  |                                      |  |
| 85 ton  |  | 90 ton  |  | 95 ton  |  | 120 ton   |  | 120 ton   |  | 135 ton  |  | 150 ton   |  |   |  |                                      |  |
| 1-1/16" in 1"   |  | 1-1/8" in 1"  |  | 1-3/16" in 1"   |  | 1-1/2" in 1"  |  | 1-1/2" in 1"  |  | 1-11/16" in 1"   |  | 1-7/8" in 1"  |  |   |  |                                      |  |
| 4"  |  | 4"  |  | 4"  |  | 4"  |  | 4"  |  | 4"   |  | 4"  |  | N/A   |  |                                      |  |
| 20"   |  | 24"   |  | 24"   |  | 24"   |  | 24"   |  | 24"  |  | 24"   |  |   |  |                                      |  |
| 1" x 14"<br>3/4" x 20"  |  | 1" x 8"<br>3/4" x 12"<br>1/2" x 16"<br>1/4" x 24"                                   |  | 1" x 8"<br>3/4" x 12"<br>1/2" x 16"<br>3/8" x 24"                                   |  | 1" x 12"<br>3/4" x 20"<br>1/2" x 24"  |  | 1" x 12"<br>3/4" x 20"<br>1/2" x 24"  |  | 1" x 12"<br>3/4" x 20"<br>1/2" x 24"   |  | 1" x 14"<br>3/4" x 24"  |  |   |  | 1" x 12"<br>3/4" x 16"<br>1/2" x 24" |  |
| 6" x 6" x 1/2"  |  | 6" x 6" x 1/2"  |  | 6" x 6" x 1/2"  |  | 6" x 6" x 1/2"  |  | 6" x 6" x 1/2"  |  | 6" x 6" x 1/2"   |  | 6" x 6" x 1/2"  |  |   |  |                                      |  |
| 4" x 4" x 1/2"<br>(with bar shear)  |  | 3" x 3" x 3/8"<br><br>4" x 4" x 1/2"<br>(with bar shear)                            |  | 3" x 3" x 3/8"<br><br>4" x 4" x 1/2"<br>(with bar shear)                            |  | 3" x 3" x 3/8"<br><br>4" x 4" x 1/2"<br>(with bar shear)                            |  | 3" x 3" x 3/8"<br><br>4" x 4" x 1/2"<br>(with bar shear)                            |  | 3" x 3" x 3/8"<br><br>4" x 4" x 1/2"<br>(with bar shear)                             |  | 3" x 3" x 3/8"<br><br>4" x 4" x 1/2"<br>(with bar shear)                              |  |   |  |                                      |  |
| 2" to 6"  |  | 2" to 6"<br>adjustable  |  | 2" to 6"<br>adjustable  |  | 2" to 6"<br>adjustable  |  | 2" to 6"<br>adjustable  |  | 2" to 6"<br>adjustable   |  | 2" to 6"<br>adjustable  |  |   |  |                                      |  |
| 1/2", 3/4", 1",<br>1-1/2", 4 cavity   |  | 1/4" to 1-1/4",<br>9 cavity   |  | 1/4" to 1-1/4",<br>9 cavity   |  | 1/4" to 1-1/4",<br>9 cavity   |  | 1/4" to 1-1/4",<br>9 cavity   |  | 1/4" to 1-1/4",<br>9 cavity  |  | 1/4" to 1-1/4",<br>9 cavity   |  |   |  |                                      |  |
| 1-1/2",<br>1 cavity   |  | 1/4" to 1",<br>1 cavity   |  | 1/4" to 1",<br>1 cavity   |  | 1/4" to 1",<br>1 cavity   |  | 1/4" to 1",<br>1 cavity   |  | 1/4" to 1",<br>1 cavity  |  | 1/4" to 1",<br>1 cavity   |  |   |  |                                      |  |
| 1/2" to 2",<br>12 gauge   |  | 1/2" to 2",<br>12 gauge   |  | 1/2" to 2",<br>12 Gauge   |  | 1/2" to 2",<br>12 gauge   |  | 1/2" to 2",<br>12 gauge   |  | 1/2" to 2",<br>12 gauge  |  | 1/2" to 2",<br>12 gauge   |  |   |  |                                      |  |
| 2" x 4" x 1/2"  |  | 2" x 2-1/2" x 3/8"  |  | 3" x 5" x 3/8"<br>3" x 4" x 1/2"  |  | 2" x 2-1/2" x 3/8"  |  | 3" x 5-3/4" x 1/2"  |  | 3" x 5-3/4" x 1/2"   |  | 3" x 5-3/4" x 1/2"  |  |   |  |                                      |  |
| 3" x 3" x 1/2"<br>(Notcher Station)<br>6" x 6" x 5/16"<br>(Punch Station)           |  | 6" x 6" x 5/16"   |  | 6" x 6" x 5/16"   |  | 6" x 6" x 5/16"   |  | 6" x 6" x 5/16"   |  | 6" x 6" x 5/16"  |  | 6" x 6" x 5/16"   |  |   |  |                                      |  |
| 3/4" to 2"  |  | 3/4" to 2"  |  | 3/4" to 2"  |  | 3/4" to 2"  |  | 3/4" to 2"  |  | 3/4" to 2"   |  | 3/4" to 2"  |  |   |  |                                      |  |
| 12", 24",<br>6" Open-End  |  | 12", 24",<br>6" Open-End  |  | 12", 24",<br>6" Open-End  |  | 12", 24",<br>6" Open-End  |  | 12", 24",<br>6" Open-End  |  | 12", 24",<br>6" Open-End   |  | 12", 24",<br>6" Open-End  |  |   |  |                                      |  |
| 1/2", 3/4", & 1"<br>(16 gauge)  |  | 1/2", 3/4", & 1"<br>(16 gauge)  |  | 1/2", 3/4", & 1"<br>(16 gauge)  |  | 1/2", 3/4", & 1"<br>(16 gauge)  |  | 1/2", 3/4", & 1"<br>(16 gauge)  |  | 1/2", 3/4", & 1"<br>(16 gauge)   |  | 1/2", 3/4", & 1"<br>(16 gauge)  |  |   |  |                                      |  |
| 230/460v, 3 ph<br>220v, 1 ph  |  | 230/460v, 3 ph<br>220v, 1 ph  |  | 230/460v, 3 ph<br>220v, 1 ph  |  | 230/460v, 3 ph<br>220v, 1 ph  |  | 230/460v, 3 ph<br>220v, 1 ph  |  | 230/460v, 3 ph<br>220v, 1 ph   |  | 230/460v, 3 ph<br>220v, 1 ph  |  |   |  |                                      |  |
|  |  |  |  |  |  |  |  |  |  |  |  |  |  |  |  |                                      |  |
| DO 85   |  | 9012  |  | DO 95   |  | 12012   |  | DO 120  |  | DO 135   |  | DO 150  |  | ShearMaster 610   |  |                                      |  |
| Page 14   |  | Page 15   |  | Page 16   |  | Page 17   |  | Page 18   |  | Page 19  |  | Page 20   |  | Page 25   |  |                                      |  |

# 45 Ton

IRONWORKERS



**SINGLE OPERATOR**  
**4 STATIONS**

## PORTA FAB 45

### Capacities and Specifications

Rated On: A36 Mild Steel / 65,000 PSI Tensile

|   |   |
|---|---|
| <b>Punching Capacity</b>                    | 45 ton (41 mt)<br>1-1/8" in 1/2" (28 mm in 12 mm)                                     |
| <b>Special Tooling</b>                      | 2-1/4" (57 mm) Max. Dia.  |
| <b>Throat Depth</b>                         | 4-1/4" (108 mm)   |
| <b>Flat Bar Shear</b>                       | 6" Length (152 mm)<br>1/2" x 4" (12 x 102 mm)<br>3/8" x 6" (10 x 152 mm)              |
| <b>Angle Shear 90°</b>                      | 3" x 3" x 5/16" (76 x 76 x 8 mm)  |
| <b>Angle Shear 45°</b>                      | 2" x 2" x 1/4" (51 x 51 x 6 mm)   |
| <b>Round Rod Shear</b>                      | 3/4" (19 mm)  |
| <b>Brake 8"</b>                             | 25 ton (23 mt)  |
| <b>Brake 12"</b>                            | 20 ton (18 mt)  |
| <b>Open End Brake</b>                       | Max. 1/4" x 3" (6 x 76 mm)<br>[Flat or Angle Iron]                                    |
| <b>Pipe Notcher Schedule 40</b>             | 3/4", 1", 1-1/4", 1-1/2", 2"  |
| <b>Rectangle Notcher</b>                    | 2" x 1-3/4" x 1/4" (51 x 44 x 6 mm)   |
| <b>90° V-Notcher</b>                        | 6" x 6" x 1/8" (152 x 152 x 3 mm)   |
| <b>Rod Shear Round (max.)</b>               | 5 Cavity, 1/4" to 1" (6 mm to 25 mm)  |
| <b>Rod Shear Square (max.)</b>              | 1 Cavity, 1/4" to 3/4" (6 mm to 19 mm)  |
| <b>Unistrut Shear</b>                       | Samples Required  |
| <b>Square Tube Shear</b>                    | 1/2" to 1" (12 mm to 25 mm)<br>12 gauge (0.105" / 2.7 mm)                             |
| <b>Picket Tool</b>                          | 1/2", 3/4" & 1" (12 mm, 19 mm, 25 mm)<br>16 gauge (0.06" / 1.5 mm)                    |
| <b>Weld Coupon Bender (max.)</b>            | 2" wide x 3/8" (51 mm x 10 mm)  |
| <b>Strokes per minute in light material</b> | 10 spm (1/4" stroke) [Punch Station]  |
| <b>Strokes per minute in heavy material</b> | 4 spm (3/4" stroke) [Punch Station]   |
| <b>Hydraulics</b>                           | 2,500 psi (172 bar)   |
| <b>Motor Options (must specify)</b>         | 2 hp 110 v<br>2 hp 1 ph (1.49 kW) 220 v   |
| <b>Dimensions</b>                           | L-38-1/4" (97 cm)<br>W-20" (51 cm)<br>H-39-1/4" (100 cm)<br>H w/base-56-3/4" (144 cm) |
| <b>Shipping Weight (may vary)</b>           | 710 lbs. (322 kg)   |

### STANDARD FEATURES

- 45 ton punch station
- Keyed punch ram for safety
- 2" die holder
- Punch nut with wrench and stripper
- One round punch & die: max. diameter 1"
- Electric remote foot pedal
- Adjustable electric stroke control with scale
- Three-in-one combination tool: Angle shear, Bar shear, and Rod shear
- 14" Tool table work area
- Slug receptacle
- Machine stand with punch & die & tooling storage rack
- 110 volt electrics
- Complies with ANSI B 11.5 safety standards
- Three-year warranty on parts
- Made in USA



# 45 Ton

IRONWORKERS

**It's portable, versatile, and designed for in-plant or on-the-job operation; a perfect choice for the fabricator on-the-go!**

With 45-ton punching capacity, this ironworker can punch 1-1/8" hole through 1/2" mild steel and runs on 110-volt power from your standard wall outlet or generator. A 3-in-1 combination tool comes standard and is located in our unique tool table area. This versatile workstation allows additional tooling to be easily swapped in and out so you can customize the machine to fit your needs.

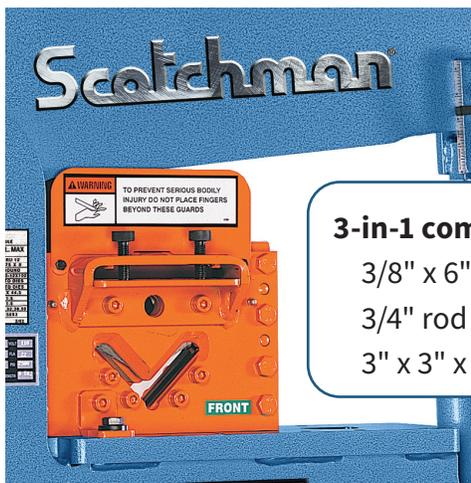

**3-in-1 combination tool:**

- 3/8" x 6" flat bar shear
- 3/4" rod shear
- 3" x 3" x 5/16" angle shear

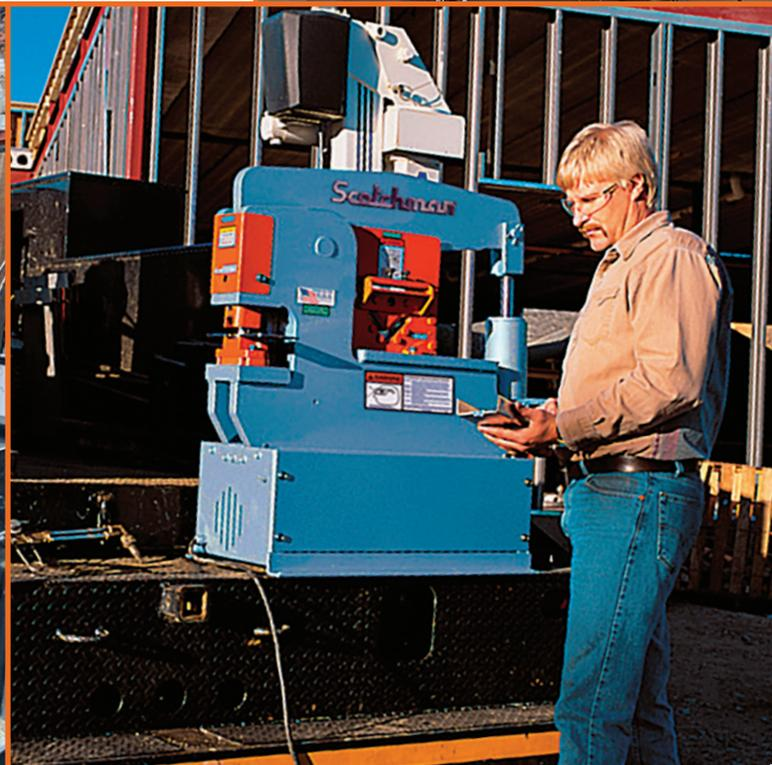
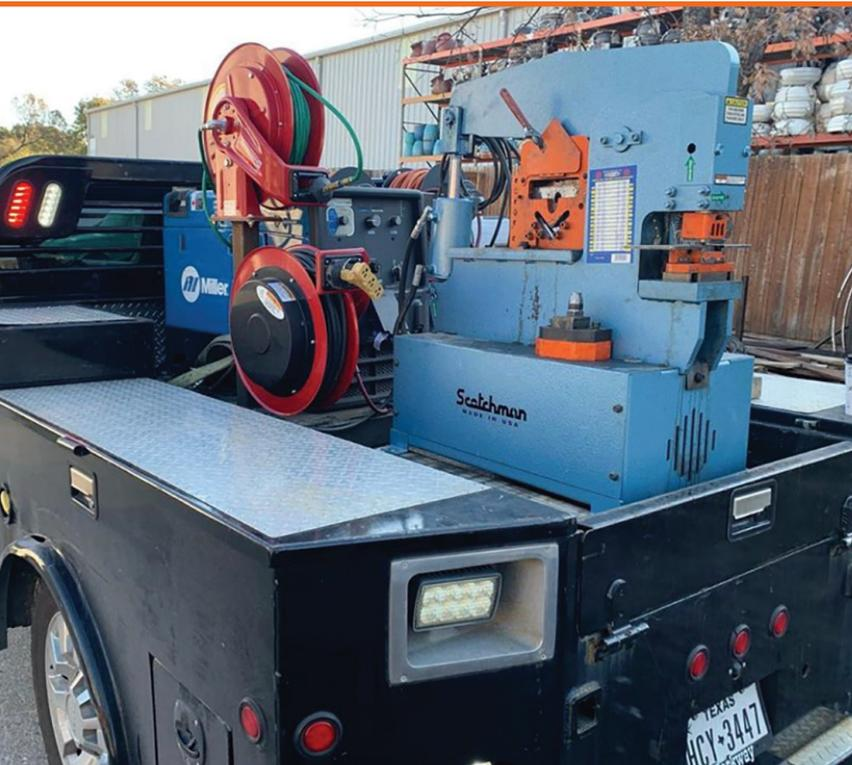

# 50 Ton

IRONWORKERS



**SINGLE OPERATOR**  
**5 STATIONS**

**50514-EC**

Single punch station



**SINGLE OPERATOR**  
**7 STATIONS**

**5014-ET**

3-station revolving turret punch

## STANDARD FEATURES

- 50 ton punch station
- 2" die holder (per punch station)
- Punch nut & stripper (per punch station)
- One round punch & die: max. diameter 1"
- Keyed punch ram for safety
- Adjustable electric stroke control with scale
- Electric remote foot pedal
- Angle shear
- Flat bar shear with 4-way reversible blade
- Rectangle notcher
- LED Work Lights
- 14" Tool table work area
- Slug receptacle
- Electrical box supplied with emergency palm button and lock-out tag-out accommodations
- Complies with ANSI B 11.5 safety standards
- Forklift accommodations
- Three-year warranty on parts
- Made in USA

## 50514-EC

## 5014-ET

| Capacities and Specifications                 |  |  |
|---|--|--|
| Rated On: A36 Mild Steel / 65,000 PSI Tensile |  |  |
| <b>Punching Capacity</b>                      | 50 ton (45 mt)<br>1-1/4" in 1/2" (32 mm in 12 mm)<br>13/16" in 3/4" (20 mm in 19 mm)   | 50 ton (45 mt)<br>1-1/4" in 1/2" (32 mm in 12 mm)<br>13/16" in 3/4" (20 mm in 19 mm)   |
| <b>Special Tooling</b>                        | 2-1/4" (57 mm) Max. Dia.   | 2-1/4" (57 mm) Max. Dia.   |
| <b>Throat Depth</b>                           | 6" (152 mm)  | 4" (102 mm)  |
| <b>Flat Bar Shear</b>                         | 14" Length (356 mm)<br>3/4" x 4" (19 x 102 mm)<br>1/2" x 8" (12 x 203 mm)<br>3/8" x 10" (10 x 254 mm)<br>1/4" x 14" (6 x 356 mm) | 14" Length (356 mm)<br>3/4" x 4" (19 x 102 mm)<br>1/2" x 8" (12 x 203 mm)<br>3/8" x 10" (10 x 254 mm)<br>1/4" x 14" (6 x 356 mm) |
| <b>Opt. Sabre Blade</b>                       | 1/2" x 10" (12 x 254 mm)<br>3/8" x 12" (10 x 305 mm)   | 1/2" x 10" (12 x 254 mm)<br>3/8" x 12" (10 x 305 mm)   |
| <b>Angle Shear 90°</b>                        | 4" x 4" x 3/8" (102 x 102 x 10 mm)   | 4" x 4" x 3/8" (102 x 102 x 10 mm)   |
| <b>Angle Shear 45°</b>                        | 2" x 2" x 1/4" (51 x 51 x 6 mm)  | 2" x 2" x 1/4" (51 x 51 x 6 mm)  |
| <b>Brake 8"</b>                               | 30 ton (27 mt)   | 25 ton (23 mt)   |
| <b>Brake 12"</b>                              | 25 ton (23 mt)   | 25 ton (23 mt)   |
| <b>Open End Brake</b>                         | Max. 1/4" x 3" (6 x 76 mm)<br>[Flat or Angle Iron]   | Max. 1/4" x 3" (6 x 76 mm)<br>[Flat or Angle Iron]   |
| <b>Pipe Notcher Schedule 40</b>               | 3/4", 1", 1-1/4", 1-1/2", 2"   | 3/4", 1", 1-1/4", 1-1/2", 2"   |
| <b>Rectangle Notcher</b>                      | 2-1/2" x 3" x 5/16" (63 x 76 x 8 mm)<br>2-1/2" x 2-3/4" x 3/8" (63 x 70 x 10 mm)   | 2-1/2" x 3" x 5/16" (63 x 76 x 8 mm)<br>2-1/2" x 2-3/4" x 3/8" (63 x 70 x 10 mm)   |
| <b>90° V-Notcher</b>                          | 6" x 6" x 1/8" (152 x 152 x 3 mm)<br>3" x 3" x 1/4" (76 x 76 x 6 mm)   | 6" x 6" x 1/8" (152 x 152 x 3 mm)<br>3" x 3" x 1/4" (76 x 76 x 6 mm)   |
| <b>Unistrut Shear</b>                         | Samples Required   | Samples Required   |
| <b>Rod Shear Round (max.)</b>                 | 5 Cavity, 1/4" to 1" (6 mm to 25 mm)   | 5 Cavity, 1/4" to 1" (6 mm to 25 mm)   |
| <b>Rod Shear Square (max.)</b>                | 1 Cavity, 1/4" to 3/4" (6 mm to 19 mm)   | 1 Cavity, 1/4" to 3/4" (6 mm to 19 mm)   |
| <b>Square Tube Shear</b>                      | 1/2" to 1" (12 mm to 25 mm)<br>12 gauge (0.105" / 2.7 mm)  | 1/2" to 1" (12 mm to 25 mm)<br>12 gauge (0.105" / 2.7 mm)  |
| <b>Picket Tool</b>                            | 1/2", 3/4" & 1" (12 mm, 19 mm, 25 mm)<br>16 gauge (0.06" / 1.5 mm)   | 1/2", 3/4" & 1" (12 mm, 19 mm, 25 mm)<br>16 gauge (0.06" / 1.5 mm)   |
| <b>Weld Coupon Bender (max.)</b>              | 2" wide x 3/8"<br>(51 mm x 10 mm)  | 2" wide x 3/8"<br>(51 mm x 10 mm)  |
| <b>Strokes per minute in light material</b>   | 34 spm (1/4" stroke) [Punch Station]   | 34 spm (1/4" stroke) [Punch Station]   |
| <b>Strokes per minute in heavy material</b>   | 14 spm (3/4" stroke) [Punch Station]   | 14 spm (3/4" stroke) [Punch Station]   |
| <b>Hydraulics</b>                             | 2,350 psi (162 bar)  | 2,350 psi (162 bar)  |
| <b>Motor Options (must specify)</b>           | 3 hp 3 ph (2.24 kW) 208/230/460, 380/575v<br>5 hp 1 ph (3.73 kW) 220v  | 3 hp 3 ph (2.24 kW) 208/230/460, 380/575v<br>5 hp 1 ph (3.73 kW) 220v  |
| <b>Dimensions</b>                             | L-48-1/4" (122.5 cm)<br>W-23-1/2" (60 cm)<br>H-63-3/4" (161 cm)  | L-48-1/4" (122.5 cm)<br>W-23-1/2" (60 cm)<br>H-70-1/4" (178.5 cm)  |
| <b>Shipping Weight (may vary)</b>             | 1,580 lbs. (717 kg)  | 1,640 lbs. (744 kg)  |



# 65 Ton

IRONWORKERS



**SINGLE OPERATOR**

**4 STATIONS**

## 6509-24M

### Capacities and Specifications

Rated On: A36 Mild Steel / 65,000 PSI Tensile

|   |   |
|---|---|
| <b>Punching Capacity</b>                    | 65 ton (58 mt)<br>1-1/16" in 3/4" (27 mm in 19 mm)  |
| <b>Special Tooling</b>                      | 4" (102 mm) Max. Dia.   |
| <b>Throat Depth</b>                         | 9" (229 mm)   |
| <b>Flat Bar Shear</b>                       | 24" Length (610 mm)<br>1" x 6" (25 x 152 mm)<br>3/4" x 10" (19 x 254 mm)<br>1/2" x 12" (12 x 305 mm)<br>3/8" x 16" (10 x 406 mm)<br>1/4" x 24" (6 x 610 mm) |
| <b>Opt. Sabre Blade</b>                     | 1" x 6" (25 x 152 mm)<br>1/2" x 16" (12 x 406 mm)   |
| <b>Angle Shear 90°</b>                      | 6" x 6" x 3/8" (152 x 152 x 10 mm)<br>5" x 5" x 1/2" (127 x 127 x 12 mm)  |
| <b>Angle Shear 45° w/Tool</b>               | 3" x 3" x 3/8" (76 x 76 x 10 mm)  |
| <b>w/Bar Shear</b>                          | 4" x 4" x 1/2" (102 x 102 x 12 mm)  |
| <b>Brake 12"</b>                            | 40 ton (36 mt)  |
| <b>Brake 24"</b>                            | 30 ton (27 mt)  |
| <b>Open End Brake</b>                       | Max. 1/4" x 5" (6 x 127 mm)<br>[Flat or Angle Iron]   |
| <b>Pipe Notcher Schedule 40</b>             | 3/4", 1", 1-1/4", 1-1/2", 2"  |
| <b>Rectangle Notcher</b>                    | 2" x 2-1/2" x 3/8" (51 x 63 x 10 mm)  |
| <b>90° V-Notcher</b>                        | 6" x 6" x 5/16" (152 x 152 x 8 mm)  |
| <b>Channel Shear</b>                        | 2" to 5" adj. (51 mm to 127 mm adj.)  |
| <b>Unistrut Shear</b>                       | Samples Required  |
| <b>Rod Shear Round (max.)</b>               | 9 Cavity, 1/4" to 1-1/4" (6 mm to 32 mm)  |
| <b>Rod Shear Square (max.)</b>              | 1 Cavity, 1/4" to 1" (6 mm to 25 mm)  |
| <b>Square Tube Shear</b>                    | 1/2" to 2" (12 mm to 51 mm)<br>12 gauge (0.105" / 2.7 mm)   |
| <b>Picket Tool</b>                          | 1/2", 3/4" & 1" (12 mm, 19 mm, 25 mm)<br>16 gauge (0.06" / 1.5 mm)  |
| <b>Weld Coupon Bender (max.)</b>            | 2" wide x 3/8" (51 mm x 10 mm)  |
| <b>Offset Die Holder</b>                    | Max. 40 ton (36 mt)   |
| <b>Strokes per minute in light material</b> | 58 spm (1/4" stroke) [Punch Station]  |
| <b>Strokes per minute in heavy material</b> | 26 spm (3/4" stroke) [Punch Station]  |
| <b>Hydraulics</b>                           | 2,600 psi (183 bar)   |
| <b>Motor Options (must specify)</b>         | 5 hp 3 ph (3.73 kW) 208/230/460, 380/575v<br>5 hp 1 ph (3.73 kW) 220v   |
| <b>Dimensions</b>                           | L-60-3/4" (154.5 cm)<br>W-30" (76 cm)<br>H-64-1/2" (164 cm)   |
| <b>Shipping Weight (may vary)</b>           | 2,984 lbs. (1,354 kg)   |

### STANDARD FEATURES

- 65 ton punch station
- Keyed punch ram for safety
- Punch gauging table w/fence and scale
- Die holder complete with 2" die insert
- Punch nut with wrench and stripper
- One round punch & die: max. diameter 1-1/4"
- Jog control
- Adjustable electric stroke control with scale
- Electric remote foot pedal
- Flat bar shear with 4-way reversible blade
- Shear table with miter fence
- Angle shear
- LED Work Lights
- 24" Tool table work area
- Slug receptacle
- Two-stage hydraulic pump
- Electrical box supplied with emergency palm button and lock-out tag-out accommodations
- Complies with ANSI B 11.5 safety standards
- Forklift accommodations
- Three-year warranty on parts
- Made in USA





**DUAL  
OPERATOR**  
**5 STATIONS**

## DO 70/110-24M

### Capacities and Specifications

Rated On: A36 Mild Steel / 65,000 PSI Tensile

|   |  |
|---|--|
| <b>Punching Capacity</b>                    | 70 ton (63 mt)<br>1-1/8" in 3/4" (29 mm in 19 mm)  |
| <b>Special Tooling</b>                      | 4" (102 mm) Max. Dia.  |
| <b>Throat Depth</b>                         | 9" (229 mm)  |
| <b>Flat Bar Shear (sabre blade-std.)</b>    | 24" Length (610 mm)<br>1" x 6" (25 x 152 mm)<br>3/4" x 10" (19 x 254 mm)<br>1/2" x 14" (12 x 356 mm)<br>3/8" x 24" (10 x 610 mm) |
| <b>Angle Shear 90°</b>                      | 6" x 6" x 1/2" (152 x 152 x 12 mm)   |
| <b>Angle Shear 45°</b>                      |  |
| <b>w/Tool</b>                               | 3" x 3" x 3/8" (76 x 76 x 10 mm)   |
| <b>w/Bar Shear</b>                          | 4" x 4" x 1/2" (102 x 102 x 12 mm)   |
| <b>Brake 12"</b>                            | 65 ton (59 mt)   |
| <b>Brake 24"</b>                            | 45 ton (40 mt)   |
| <b>Open End Brake</b>                       | Max. 1/4" x 5" (6 x 127 mm)<br>[Flat or Angle Iron]  |
| <b>Pipe Notcher Schedule 40</b>             | 3/4", 1", 1-1/4", 1-1/2", 2"   |
| <b>Rectangle Notcher</b>                    | 3" x 5" x 3/8" (76 x 127 x 10 mm)<br>3" x 4" x 1/2" (76 x 101 x 12 mm)   |
| <b>90° V-Notcher</b>                        | 6" x 6" x 5/16" (152 x 152 x 8 mm)<br>3" x 3" x 3/8" (76 x 76 x 10 mm)   |
| <b>Notching in Leg of Channel</b>           | 6" to 10" (152 mm to 254 mm)   |
| <b>Channel Shear</b>                        | 2" to 6" adj. (51 mm to 152 mm adj.)   |
| <b>Unistrut Shear</b>                       | Samples Required   |
| <b>Rod Shear Round (max.)</b>               | 9 Cavity, 1/4" to 1-1/4" (6 mm to 32 mm)   |
| <b>Rod Shear Square (max.)</b>              | 1 Cavity, 1/4" to 1" (6 mm to 25 mm)   |
| <b>Square Tube Shear</b>                    | 1/2" to 2" (12 mm to 51 mm)<br>12 gauge (0.105" / 2.7 mm)  |
| <b>Picket Tool</b>                          | 1/2", 3/4" & 1" (12 mm, 19 mm, 25 mm)<br>16 gauge (0.06" / 1.5 mm)   |
| <b>Weld Coupon Bender (max.)</b>            | 2" wide x 3/8" (51 mm x 10 mm)   |
| <b>Offset Die Holder</b>                    | Max. 40 ton (36 mt)  |
| <b>Strokes per minute in light material</b> | 38 spm (1/4" stroke) [Punch Station]   |
| <b>Strokes per minute in heavy material</b> | 15 spm (3/4" stroke) [Punch Station]   |
| <b>Hydraulics</b>                           | 3,000/3,000 psi (207/207 bar)  |
| <b>Motor Options (must specify)</b>         | 10 hp 3 ph (7.46 kW) 208/230/460, 380/575v<br>10 hp 1 ph (7.46 kW) 220v  |
| <b>Dimensions</b>                           | L-69" (175 cm)<br>W-37-1/2" (95 cm)<br>H-71" (180 cm)  |
| <b>Shipping Weight (may vary)</b>           | 3,800 lbs. (1,724 kg)  |

IRONWORKERS

### STANDARD FEATURES

- Dual operator allows for two operators to work at the same time at full capacity
- 70 ton punch station
- Keyed punch ram for safety
- Punch gauging table with fence and scale
- Die holder complete with 2" die insert
- Punch nut with wrench & stripper
- Adjustable swing-away stripper
- One round punch & die: max. diameter 1-1/4"
- Jog control
- Two adjustable electric stroke controls with scale
- Two electric remote foot pedals
- Tandem hydraulic pump
- Two valves
- Angle shear
- Rectangle notcher with table, scale and guides
- Flat bar shear with sabre blade
- Shear table with miter fence
- LED Work Lights
- 24" Tool table work area
- Slug receptacles
- Electrical box supplied with emergency palm button and lock-out tag-out accommodations
- Complies with ANSI B 11.5 safety standards
- Forklift accommodations
- Three-year warranty on parts
- Made in USA



# 85 Ton

IRONWORKERS



**SINGLE OPERATOR**  
**5 STATIONS**

## FI 8510-20M

### Capacities and Specifications

Rated On: A36 Mild Steel / 65,000 PSI Tensile

|   |   |
|---|---|
| <b>Punching Capacity</b>                    | 85 ton (77 mt)<br>1-1/16" in 1" (27 mm in 25 mm)                          |
| <b>Special Tooling</b>                      | 4" (102 mm) Max. Dia.   |
| <b>Throat Depth</b>                         | 10" (254 mm)  |
| <b>Flat Bar Shear (sabre blade-std.)</b>    | 20" Length (508 mm)<br>1" x 12" (25 x 305 mm)<br>3/4" x 20" (19 x 508 mm) |
| <b>Angle Shear 90°</b>                      | 6" x 6" x 1/2" (152 x 152 x 12 mm)  |
| <b>Angle Shear 45° (with Bar Shear)</b>     | 4" x 4" x 1/2" (102 x 102 x 12 mm)  |
| <b>Brake 12"</b>                            | 85 ton (77 mt)  |
| <b>Brake 24"</b>                            | 85 ton (77 mt)  |
| <b>Open End Brake</b>                       | Max. 1/4" x 5" (6 x 127 mm)<br>[Flat or Angle Iron]                       |
| <b>Pipe Notcher Schedule 40</b>             | 3/4", 1", 1-1/4", 1-1/2", 2"  |
| <b>Rectangle Notcher</b>                    | 3" x 5" x 1/2" (76 x 127 x 12 mm)   |
| <b>90° V-Notcher (Punch Station)</b>        | 6" x 6" x 5/16" (152 x 152 x 8 mm)  |
| <b>Channel Shear</b>                        | 2" to 6" adj. (51 mm to 152 mm adj.)                                      |
| <b>Unistrut Shear</b>                       | Samples Required  |
| <b>Rod Shear Round (max.)</b>               | 1 cavity, 1-1/2" (38 mm)  |
| <b>Rod Shear Square (max.)</b>              | 1 cavity, 1-1/4" (32 mm)  |
| <b>Square Tube Shear</b>                    | 1/2" to 2" (12 mm to 51 mm)<br>12 gauge (0.105" / 2.7 mm)                 |
| <b>Picket Tool</b>                          | 1/2", 3/4" & 1" (12 mm, 19 mm, 25 mm)<br>16 gauge (0.06" / 1.5 mm)        |
| <b>Weld Coupon Bender (max.)</b>            | 2" wide x 3/8"<br>(51 mm x 10 mm)   |
| <b>Offset Die Holder</b>                    | Max. 40 ton (36 mt)   |
| <b>Strokes per minute in light material</b> | 51 spm (1/4" stroke) [Punch Station]                                      |
| <b>Strokes per minute in heavy material</b> | 24 spm (3/4" stroke) [Punch Station]                                      |
| <b>Hydraulics</b>                           | 2,600 psi (179 bar)   |
| <b>Motor Options (must specify)</b>         | 5 hp 3 ph (3.76 kW) 208/230/460, 380/575v<br>5 hp 1 ph (3.76 kW) 220v     |
| <b>Dimensions</b>                           | L-67-3/4" (172 cm)<br>W-32" (81.5 cm)<br>H-78" (198 cm)                   |
| <b>Shipping Weight (may vary)</b>           | 4,554 lbs. (2,066 kg)   |

### STANDARD FEATURES

- 85 ton punch station
- Keyed punch ram for safety
- Punch gauging table with fence and scale
- Die holder complete with 2" die insert
- Punch nut with wrench & stripper
- Adjustable swing-away stripper
- One round punch & die: max. diameter 1-1/4"
- Punch jog control
- Adjustable electric stroke control with scale
- Electric remote foot pedal
- Slug-less angle shear
- Flat bar shear with sabre blade
- Shear table with miter fence
- Rod shear
- Slug receptacles
- Rectangle notcher with table, scale and guide
- LED Work Lights
- Two-stage hydraulic pump
- Electrical box supplied with emergency palm button and lock-out tag-out accommodations
- Complies with ANSI B 11.5 safety standards
- Forklift accommodations
- Three-year warranty on parts
- Made in USA



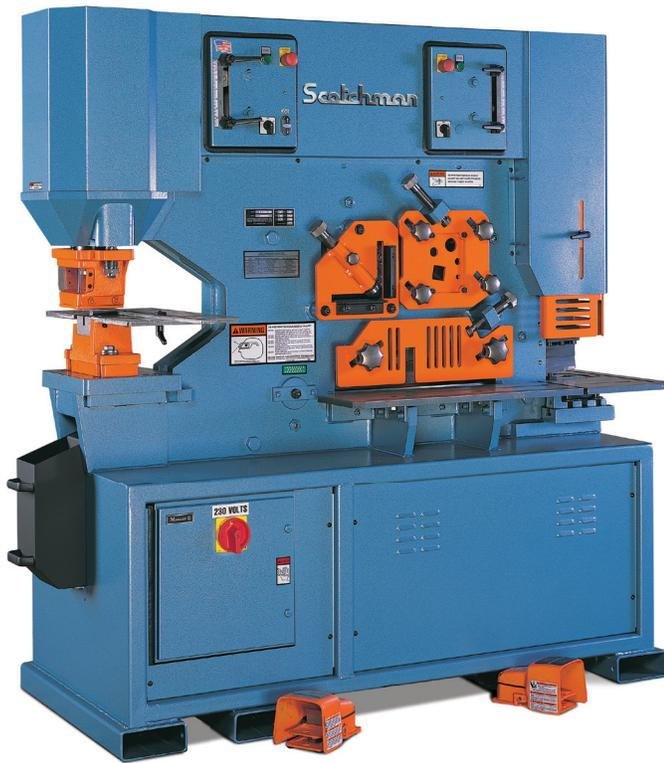

**DUAL  
OPERATOR**  
**5 STATIONS**

## DO 8514-20M

### Capacities and Specifications

Rated On: A36 Mild Steel / 65,000 PSI Tensile

|   |  |
|---|--|
| <b>Punching Capacity</b>                                  | 85 ton (77 mt)<br>1-1/16" in 1" (27 mm in 25 mm)                           |
| <b>Special Tooling</b>                                    | 4" (102 mm) Max. Dia.  |
| <b>Throat Depth</b>                                       | 14" (355 mm)   |
| <b>Flat Bar Shear (sabre blade-std.)</b>                  | 20" Length, (508 mm)<br>1" x 14" (25 x 355 mm)<br>3/4" x 20" (19 x 508 mm) |
| <b>Angle Shear 90°</b>                                    | 6" x 6" x 1/2" (152 x 152 x 12 mm)   |
| <b>Angle Shear 45° (with Bar Shear)</b>                   | 4" x 4" x 1/2" (102 x 102 x 12 mm)   |
| <b>Brake 12"</b>  | 85 ton (77 mt)   |
| <b>Brake 24"</b>  | 85 ton (77 mt)   |
| <b>Open End Brake (Notcher Station)</b>                   | Max. 1/2" x 6" (12 x 152 mm)<br>[Flat or Angle Iron]                       |
| <b>Open End Brake (Punch Station)</b>                     | Max. 1/4" x 5" (6 x 127 mm)<br>[Flat or Angle Iron]                        |
| <b>Pipe Notcher Schedule 40</b>                           | 3/4", 1", 1-1/4", 1-1/2", 2"   |
| <b>Rectangle Notcher</b>                                  | 2" x 4" x 1/2" (51 x 101 x 12 mm)  |
| <b>90° V-Notcher (Punch Station)</b>                      | 6" x 6" x 5/16" (152 x 152 x 8 mm)   |
| <b>90° V-Notcher (Notcher Station)</b>                    | 3" x 3" x 1/2" (76 x 76 x 12 mm)   |
| <b>Punch Attachment (Notcher Station)</b>                 | 50 ton 1-1/4" in 1/2" (32 mm in 12 mm)                                     |
| <b>Throat Depth w/ Punch attachment (Notcher Station)</b> | 4-7/16" (113 mm)   |
| <b>Channel Shear</b>                                      | 2" to 6" (51 mm to 152 mm)   |
| <b>Unistrut Shear</b>                                     | Samples Required   |
| <b>Rod Shear Round (max.)</b>                             | 4 cavities, 1/2", 3/4", 1", 1-1/2"<br>(12 mm, 19 mm, 25 mm, 38 mm)         |
| <b>Rod Shear Square (max.)</b>                            | 1 cavity, 1-1/2" (38 mm)   |
| <b>Square Tube Shear</b>                                  | 1/2" to 2" (12 mm to 51 mm)<br>12 gauge (0.105" / 2.7 mm)                  |
| <b>Picket Tool</b>  | 1/2", 3/4" & 1" (12 mm, 19 mm, 25 mm)<br>16 gauge (0.06" / 1.5 mm)         |
| <b>Weld Coupon Bender (max.)</b>                          | 2" wide x 3/8"<br>(51 mm x 10 mm)  |
| <b>Offset Die Holder</b>                                  | Max. 40 ton (36 mt)  |
| <b>Strokes per minute in light material</b>               | 45 spm (1/4" stroke) [Punch Station]                                       |
| <b>Strokes per minute in heavy material</b>               | 18 spm (3/4" stroke) [Punch Station]                                       |
| <b>Hydraulics</b>   | 3,350/3,800 psi (231/262 bar)  |
| <b>Motor Options (must specify)</b>                       | 10 hp 3 ph (7.46 kW) 208/230/460, 380/575v<br>10 hp 1 ph (7.46 kW) 220v    |
| <b>Dimensions</b>   | L-77-1/2" (197 cm)<br>W-32-1/4" (82 cm)<br>H-74" (188 cm)                  |
| <b>Shipping Weight (may vary)</b>                         | 5,504 lbs. (2,497 kg)  |

IRONWORKERS

### STANDARD FEATURES

- Dual operator allows for two operators to work at the same time at full capacity
- 85 ton punch station
- Keyed punch ram for safety
- Punch gauging table with fence and scale
- Die holder complete with 2" die insert
- Punch nut with wrench & stripper
- Adjustable swing-away stripper
- One round punch & die: max. diameter 1-1/4"
- Punch jog control
- Two adjustable electric stroke controls with scale
- Two electric remote foot pedals
- Tandem hydraulic pump
- Two valves
- Slug-less angle shear
- Rectangle notcher: can be converted to a V-Notcher, 50 ton punch station, or open end brake
- Flat bar shear with sabre blade
- Shear table with miter fence
- Rod shear
- LED Work Lights
- Slug receptacles
- Electrical box supplied with emergency palm button and lock-out tag-out accommodations
- Complies with ANSI B 11.5 safety standards
- Forklift accommodations
- Three-year warranty on parts
- Made in USA





**SINGLE OPERATOR**  
**4 STATIONS**

## 9012-24M

### Capacities and Specifications

Rated On: A36 Mild Steel / 65,000 PSI Tensile

|   |   |
|---|---|
| <b>Punching Capacity</b>                    | 90 ton (80 mt)<br>1-1/8" in 1" (29 mm in 25 mm)   |
| <b>Special Tooling</b>                      | 4" (102 mm) Max. Dia.   |
| <b>Throat Depth</b>                         | 12" (305 mm)  |
| <b>Flat Bar Shear</b>                       | 24" Length (610 mm)<br>1" x 8" (25 x 203 mm)<br>3/4" x 12" (19 x 305 mm)<br>1/2" x 16" (12 x 406 mm)<br>1/4" x 24" (6 x 610 mm) |
| <b>Opt. Sabre Blade</b>                     | 1/2" x 22" (12 x 559 mm)<br>3/8" x 24" (10 x 610 mm)  |
| <b>Angle Shear 90°</b>                      | 6" x 6" x 1/2" (152 x 152 x 12 mm)  |
| <b>Angle Shear 45° w/Tool</b>               | 3" x 3" x 3/8" (76 x 76 x 10 mm)  |
| <b>w/Bar Shear</b>                          | 4" x 4" x 1/2" (102 x 102 x 12 mm)  |
| <b>Brake 12"</b>                            | 50 ton (45 mt)  |
| <b>Brake 24"</b>                            | 40 ton (36 mt)  |
| <b>Open End Brake</b>                       | Max. 1/4" x 5" (6 x 127 mm)<br>[Flat or Angle Iron]   |
| <b>Pipe Notcher Schedule 40</b>             | 3/4", 1", 1-1/4", 1-1/2", 2"  |
| <b>Rectangle Notcher</b>                    | 2" x 2-1/2" x 3/8" (51 x 63 x 10 mm)  |
| <b>90° V-Notcher</b>                        | 6" x 6" x 5/16" (152 x 152 x 8 mm)  |
| <b>Channel Shear</b>                        | 2" to 6" adj. (51 mm to 152 mm adj.)  |
| <b>Unistrut Shear</b>                       | Samples Required  |
| <b>Rod Shear Round (max.)</b>               | 9 Cavity, 1/4" to 1-1/4" (6 mm to 32 mm)  |
| <b>Rod Shear Square (max.)</b>              | 1 Cavity, 1/4" to 1" (6 mm to 25 mm)  |
| <b>Square Tube Shear</b>                    | 1/2" to 2" (12 mm to 51 mm)<br>12 gauge (0.105" / 2.7 mm)   |
| <b>Picket Tool</b>                          | 1/2", 3/4" & 1" (12 mm, 19 mm, 25 mm)<br>16 gauge (0.06" / 1.5 mm)  |
| <b>Weld Coupon Bender (max.)</b>            | 2" wide x 3/8" (51 mm x 10 mm)  |
| <b>Offset Die Holder</b>                    | Max. 40 ton (36 mt)   |
| <b>Strokes per minute in light material</b> | 45 spm (1/4" stroke) [Punch Station]  |
| <b>Strokes per minute in heavy material</b> | 24 spm (3/4" stroke) [Punch Station]  |
| <b>Hydraulics</b>                           | 2,600 psi (179 bar)   |
| <b>Motor Options (must specify)</b>         | 5 hp 3 ph (3.73 kW) 208/230/460, 380/575v<br>5 hp 1 ph (3.73 kW) 220v   |
| <b>Dimensions</b>                           | L-76-3/4" (195 cm)<br>W-31" (79 cm)<br>H-71-1/2" (181.5 cm)   |
| <b>Shipping Weight (may vary)</b>           | 4,204 lbs. (1,907 kg)   |

### STANDARD FEATURES

- 90 ton punch station
- Keyed punch ram for safety
- Punch gauging table with fence and scale
- Die holder complete with 2" die insert
- Punch nut with wrench & stripper
- One round punch & die: max. diameter 1-1/4"
- Jog control
- Adjustable electric stroke control with scale
- Electric remote foot pedal
- Angle shear
- Flat bar shear with 4-way reversible blade
- Shear table with miter fence
- LED Work Lights
- 24" Tool table work area
- Slug receptacle
- Two-stage hydraulic pump
- Electrical box supplied with emergency palm button and lock-out tag-out accommodations
- Complies with ANSI B 11.5 safety standards
- Forklift accommodations
- Three-year warranty on parts
- Made in USA



## DO 95/140-24M



**DUAL  
OPERATOR**

**5 STATIONS**

IRONWORKERS

### STANDARD FEATURES

- Dual operator allows for two operators to work at the same time at full capacity
- 95 ton punch station
- Keyed punch ram for safety
- Punch gauging table with fence and scale
- Die holder complete with 2" die insert
- Punch nut with wrench & stripper
- Adjustable swing-away stripper
- One round punch & die: max. diameter 1-1/4"
- Jog control
- Two adjustable electric stroke controls with scale
- Two electric remote foot pedals
- Tandem hydraulic pump
- Two valves
- Angle shear
- Rectangle notcher with table, scale and guides
- Flat bar shear with sabre blade
- Shear table with miter fence
- LED Work Lights
- 24" Tool table work area
- Slug receptacles
- Electrical box supplied with emergency palm button and lock-out tag-out accommodations
- Complies with ANSI B 11.5 safety standards
- Forklift accommodations
- Three-year warranty on parts
- Made in USA

### Capacities and Specifications

Rated On: A36 Mild Steel / 65,000 PSI Tensile

|   |  |
|---|--|
| <b>Punching Capacity</b>                    | 95 ton (86 mt)<br>1-3/16" in 1" (30 mm in 25 mm)   |
| <b>Special Tooling</b>                      | 4" (102 mm) Max. Dia.  |
| <b>Throat Depth</b>                         | 9" (229 mm)  |
| <b>Flat Bar Shear (sabre blade-std.)</b>    | 24" Length (610 mm)<br>1" x 8" (25 x 203 mm)<br>3/4" x 12" (19 x 305 mm)<br>1/2" x 16" (12 x 406 mm)<br>3/8" x 24" (10 x 610 mm) |
| <b>Angle Shear 90°</b>                      | 6" x 6" x 1/2" (152 x 152 x 12 mm)   |
| <b>Angle Shear 45° w/Tool w/Bar Shear</b>   | 3" x 3" x 3/8" (76 x 76 x 10 mm)<br>4" x 4" x 1/2" (102 x 102 x 12 mm)   |
| <b>Brake 12"</b>                            | 80 ton (72.5 mt)   |
| <b>Brake 24"</b>                            | 55 ton (50 mt)   |
| <b>Open End Brake</b>                       | Max. 1/4" x 5" (6 x 127 mm)<br>[Flat or Angle Iron]  |
| <b>Pipe Notcher Schedule 40</b>             | 3/4", 1", 1-1/4", 1-1/2", 2"   |
| <b>Rectangle Notcher</b>                    | 3" x 5" x 3/8" (76 x 127 x 10 mm)<br>3" x 4" x 1/2" (76 x 101 x 12 mm)   |
| <b>90° V-Notcher</b>                        | 6" x 6" x 5/16" (152 x 152 x 8 mm)<br>3" x 3" x 3/8" (76 x 76 x 10 mm)   |
| <b>Notching in Leg of Channel</b>           | 6" to 10" (152 mm to 254 mm)   |
| <b>Channel Shear</b>                        | 2" to 6" adj. (51 mm to 152 mm adj.)   |
| <b>Unistrut Shear</b>                       | Samples Required   |
| <b>Rod Shear Round (max.)</b>               | 9 Cavity, 1/4" to 1-1/4" (6 mm to 32 mm)   |
| <b>Rod Shear Square (max.)</b>              | 1 Cavity, 1/4" to 1" (6 mm to 25 mm)   |
| <b>Square Tube Shear</b>                    | 1/2" to 2" (12 mm to 51 mm)<br>12 gauge (0.105" / 2.7 mm)  |
| <b>Picket Tool</b>                          | 1/2", 3/4" & 1" (12 mm, 19 mm, 25 mm)<br>16 gauge (0.06" / 1.5 mm)   |
| <b>Weld Coupon Bender (max.)</b>            | 2" wide x 3/8" (51 mm x 10 mm)   |
| <b>Offset Die Holder</b>                    | Max. 40 ton (36 mt)  |
| <b>Strokes per minute in light material</b> | 38 spm (1/4" stroke) [Punch Station]   |
| <b>Strokes per minute in heavy material</b> | 15 spm (3/4" stroke) [Punch Station]   |
| <b>Hydraulics</b>                           | 3,500/3,500 psi (241/241 bar)  |
| <b>Motor Options (must specify)</b>         | 10 hp 3 ph (7.46 kW) 208/230/460, 380/575v<br>10 hp 1 ph (7.46 kW) 220v  |
| <b>Dimensions</b>                           | L-69" (175 cm)<br>W-37-1/2" (95 cm)<br>H-71" (180 cm)  |
| <b>Shipping Weight (may vary)</b>           | 3,800 lbs. (1,724 kg)  |





**SINGLE OPERATOR**  
**4 STATIONS**

## 12012-24M

### Capacities and Specifications

Rated On: A36 Mild Steel / 65,000 PSI Tensile

|   |   |
|---|---|
| <b>Punching Capacity</b>                    | 120 ton (108 mt)<br>1-1/2" in 1" (38 mm in 25 mm)   |
| <b>Special Tooling</b>                      | 4" (102 mm) Max. Dia.   |
| <b>Throat Depth</b>                         | 12" (305 mm)  |
| <b>Flat Bar Shear</b>                       | 24" Length (610 mm)<br>1" x 12" (25 x 305 mm)<br>3/4" x 20" (19 x 508 mm)<br>1/2" x 24" (12 x 610 mm) |
| <b>Angle Shear 90°</b>                      | 6" x 6" x 1/2" (152 x 152 x 12 mm)  |
| <b>Angle Shear 45° w/Tool</b>               | 3" x 3" x 3/8" (76 x 76 x 10 mm)  |
| <b>w/Bar Shear</b>                          | 4" x 4" x 1/2" (102 x 102 x 12 mm)  |
| <b>Brake 12"</b>                            | 83 ton (75 mt)  |
| <b>Brake 24"</b>                            | 65 ton (59 mt)  |
| <b>Open End Brake</b>                       | Max. 1/4" x 5" (6 x 127 mm)<br>[Flat or Angle Iron]   |
| <b>Pipe Notcher Schedule 40</b>             | 3/4", 1", 1-1/4", 1-1/2", 2"  |
| <b>Rectangle Notcher</b>                    | 2" x 2-1/2" x 3/8" (51 x 63 x 10 mm)  |
| <b>90° V-Notcher</b>                        | 6" x 6" x 5/16" (152 x 152 x 8 mm)  |
| <b>Channel Shear</b>                        | 2" to 6" adj. (51 mm to 152 mm adj.)  |
| <b>Unistrut Shear</b>                       | Samples Required  |
| <b>Rod Shear Round (max.)</b>               | 9 Cavity, 1/4" to 1-1/4" (6 mm to 32 mm)  |
| <b>Rod Shear Square (max.)</b>              | 1 Cavity, 1/4" to 1" (6 mm to 25 mm)  |
| <b>Square Tube Shear</b>                    | 1/2" to 2" (12 mm to 51 mm)<br>12 gauge (0.105" / 2.7 mm)   |
| <b>Picket Tool</b>                          | 1/2", 3/4" & 1" (12 mm, 19 mm, 25 mm)<br>16 gauge (0.06" / 1.5 mm)                                    |
| <b>Weld Coupon Bender (max.)</b>            | 2" wide x 3/8" (51 mm x 10 mm)  |
| <b>Offset Die Holder</b>                    | Max. 40 ton (36 mt)   |
| <b>Strokes per minute in light material</b> | 47 spm (1/4" stroke) [Punch Station]  |
| <b>Strokes per minute in heavy material</b> | 19 spm (3/4" stroke) [Punch Station]  |
| <b>Hydraulics</b>                           | 2,600 psi (179 bar)   |
| <b>Motor Options (must specify)</b>         | 5 hp 3 ph (3.73 kW) 208/230/460, 380/575v<br>5 hp 1 ph (3.73 kW) 220v                                 |
| <b>Dimensions</b>                           | L-79" (201 cm)<br>W-32" (81 cm)<br>H-75" (191 cm)   |
| <b>Shipping Weight (may vary)</b>           | 5,204 lbs. (2,360 kg)   |

### STANDARD FEATURES

- 120 ton punch station
- Keyed punch ram for safety
- Punch gauging table with fence and scale
- Die holder complete with 2" die insert
- Punch nut with wrench & stripper
- One round punch & die: max. diameter 1-1/4"
- Jog control
- Adjustable electric stroke control with scale
- Electric remote foot pedal
- Angle shear
- Flat bar shear with 4-way reversible blade
- Shear table with miter fence
- LED Work Lights
- 24" Tool table work area
- Slug receptacle
- Two-stage hydraulic pump
- Electrical box supplied with emergency palm button and lock-out tag-out accommodations
- Complies with ANSI B 11.5 safety standards
- Forklift accommodations
- Three-year warranty on parts
- Made in USA



## DO 120/200-24M

IRONWORKERS



**DUAL OPERATOR**  
**5 STATIONS**

### STANDARD FEATURES

- Dual operator allows for two operators to work at the same time at full capacity
- 120 ton punch station
- Keyed punch ram for safety
- Punch gauging table with fence and scale
- Die holder complete with 2" die insert
- Punch nut with wrench & stripper
- Adjustable swing-away stripper
- One round punch & die: max. diameter 1-1/4"
- Jog control
- Two electric remote foot pedals
- Two adjustable electric stroke controls with scale
- Tandem hydraulic pump
- Two valves
- Angle shear
- Rectangle notcher with table, scale and guides
- Flat bar shear with sabre blade
- Shear table with miter fence
- LED Work Lights
- 24" Tool table work area
- Slug receptacles
- Electrical box supplied with emergency palm button and lock-out tag-out accommodations
- Complies with ANSI B 11.5 safety standards
- Forklift accommodations
- Three-year warranty on parts
- Made in USA

| Capacities and Specifications                 |   |
|---|---|
| Rated On: A36 Mild Steel / 65,000 PSI Tensile |   |
| <b>Punching Capacity</b>                      | 120 ton (108 mt)<br>1-1/2" in 1" (38 mm in 25 mm)   |
| <b>Special Tooling</b>                        | 4" (102 mm) Max. Dia.   |
| <b>Throat Depth</b>                           | 12" (305 mm)  |
| <b>Flat Bar Shear (sabre blade-std.)</b>      | 24" Length (610 mm)<br>1" x 12" (25 x 305 mm)<br>3/4" x 20" (19 x 508 mm)<br>1/2" x 24" (12 x 610 mm) |
| <b>Angle Shear 90°</b>                        | 6" x 6" x 1/2" (152 x 152 x 12 mm)  |
| <b>Angle Shear 45° w/Tool</b>                 | 3" x 3" x 3/8" (76 x 76 x 10 mm)  |
| <b>w/Bar Shear</b>                            | 4" x 4" x 1/2" (102 x 102 x 12 mm)  |
| <b>Brake 12"</b>                              | 75 ton (55 mt)  |
| <b>Brake 24"</b>                              | 55 ton (40 mt)  |
| <b>Open End Brake</b>                         | Max. 1/4" x 5" (6 x 127 mm)<br>[Flat or Angle Iron]   |
| <b>Pipe Notcher Schedule 40</b>               | 3/4", 1", 1-1/4", 1-1/2", 2"  |
| <b>Rectangle Notcher</b>                      | 3" x 5-3/4" x 1/2" (76 x 146 x 12 mm)   |
| <b>90° V-Notcher</b>                          | 6" x 6" x 5/16" (152 x 152 x 8 mm)<br>3" x 3" x 1/2" (76 x 76 x 12 mm)                                |
| <b>Notching in Leg of Channel</b>             | 6" to 10" (152 mm to 254 mm)  |
| <b>Channel Shear</b>                          | 2" to 6" adj. (51 mm to 152 mm adj.)  |
| <b>Unistrut Shear</b>                         | Samples Required  |
| <b>Rod Shear Round (max.)</b>                 | 9 Cavity, 1/4" to 1-1/4" (6 mm to 32 mm)  |
| <b>Rod Shear Square (max.)</b>                | 1 Cavity, 1/4" to 1" (6 mm to 25 mm)  |
| <b>Square Tube Shear</b>                      | 1/2" to 2" (12 mm to 51 mm)<br>12 gauge (0.105" / 2.7 mm)   |
| <b>Picket Tool</b>                            | 1/2", 3/4" & 1" (12 mm, 19 mm, 25 mm)<br>16 gauge (0.06" / 1.5 mm)                                    |
| <b>Weld Coupon Bender (max.)</b>              | 2" wide x 3/8" (51 mm x 10 mm)  |
| <b>Offset Die Holder</b>                      | Max. 40 ton (36 mt)   |
| <b>Strokes per minute in light material</b>   | 39 spm (1/4" stroke) [Punch Station]  |
| <b>Strokes per minute in heavy material</b>   | 15 spm (3/4" stroke) [Punch Station]  |
| <b>Hydraulics</b>                             | 3,500/3,500 psi (241/241 bar)   |
| <b>Motor Options (must specify)</b>           | 10 hp 3 ph (7.46 kW) 208/230/460, 380/575v<br>10 hp 1 ph (7.46 kW) 220v                               |
| <b>Dimensions</b>                             | L-83" (211 cm)<br>W-38-1/2" (98 cm)<br>H-76-1/2" (194.5 cm)   |
| <b>Shipping Weight (may vary)</b>             | 6,204 lbs. (2,814 kg)   |



# 135 Ton

IRONWORKERS



**DUAL OPERATOR**  
**5 STATIONS**

## DO 135/220-24M

### Capacities and Specifications

Rated On: A36 Mild Steel / 65,000 PSI Tensile

|   |   |
|---|---|
| <b>Punching Capacity</b>                    | 135 ton (122 mt)<br>1-11/16" in 1" (42 mm in 25 mm)   |
| <b>Special Tooling</b>                      | 4" (102 mm) Max. Dia.   |
| <b>Throat Depth</b>                         | 12" (305 mm)  |
| <b>Flat Bar Shear (sabre blade-std.)</b>    | 24" Length (610 mm)<br>1" x 12" (25 x 305 mm)<br>3/4" x 20" (19 x 508 mm)<br>1/2" x 24" (12 x 610 mm) |
| <b>Angle Shear 90°</b>                      | 6" x 6" x 1/2" (152 x 152 x 12 mm)  |
| <b>Angle Shear 45° w/Tool</b>               | 3" x 3" x 3/8" (76 x 76 x 10 mm)  |
| <b>w/Bar Shear</b>                          | 4" x 4" x 1/2" (102 x 102 x 12 mm)  |
| <b>Brake 12"</b>                            | 90 ton (81.6 mt)  |
| <b>Brake 24"</b>                            | 70 ton (63.5 mt)  |
| <b>Open End Brake</b>                       | Max. 1/4" x 5" (6 x 127 mm)<br>[Flat or Angle Iron]   |
| <b>Pipe Notcher Schedule 40</b>             | 3/4", 1", 1-1/4", 1-1/2", 2"  |
| <b>Rectangle Notcher</b>                    | 3" x 5-3/4" x 1/2" (76 x 146 x 12 mm)   |
| <b>90° V-Notcher</b>                        | 6" x 6" x 5/16" (152 x 152 x 8 mm)<br>3" x 3" x 1/2" (76 x 76 x 12 mm)                                |
| <b>Notching in Leg of Channel</b>           | 6" to 10" (152 mm to 254 mm)  |
| <b>Channel Shear</b>                        | 2" to 6" adj. (51 mm to 152 mm adj.)  |
| <b>Unistrut Shear</b>                       | Samples Required  |
| <b>Rod Shear Round (max.)</b>               | 9 Cavity, 1/4" to 1-1/4" (6 mm to 32 mm)  |
| <b>Rod Shear Square (max.)</b>              | 1 Cavity, 1/4" to 1" (6 mm to 25 mm)  |
| <b>Square Tube Shear</b>                    | 1/2" to 2" (12 mm to 51 mm)<br>12 gauge (0.105" / 2.7 mm)   |
| <b>Picket Tool</b>                          | 1/2", 3/4" & 1" (12 mm, 19 mm, 25 mm)<br>16 gauge (0.06" / 1.5 mm)                                    |
| <b>Weld Coupon Bender (max.)</b>            | 2" wide x 3/8" (51 mm x 10 mm)  |
| <b>Offset Die Holder</b>                    | Max. 40 ton (36 mt)   |
| <b>Strokes per minute in light material</b> | 39 spm (1/4" stroke) [Punch Station]  |
| <b>Strokes per minute in heavy material</b> | 15 spm (3/4" stroke) [Punch Station]  |
| <b>Hydraulics</b>                           | 3,500/3,500 psi (241/241 bar)   |
| <b>Motor Options (must specify)</b>         | 10 hp 3 ph (7.46 kW) 208/230/460, 380/575v<br>10 hp 1 ph (7.46 kW) 220v                               |
| <b>Dimensions</b>                           | L-83" (211 cm)<br>W-38-1/2" (98 cm)<br>H-76-1/2" (194.5 cm)   |
| <b>Shipping Weight (may vary)</b>           | 6,204 lbs. (2,814 kg)   |

### STANDARD FEATURES

- Dual operator allows for two operators to work at the same time at full capacity
- 135 ton punch station
- Keyed punch ram for safety
- Punch gauging table with fence and scale
- Die Holder complete with a 2" die insert
- Punch nut with wrench & stripper
- Adjustable swing-away stripper
- One round punch & die: max. diameter 1-1/4"
- Jog control
- Two electric remote foot pedals
- Two adjustable electric stroke controls with scale
- Tandem hydraulic pump
- Two valves
- Angle shear
- Rectangle notcher with table, scale and guides
- Flat bar shear with sabre blade
- Shear table with miter fence
- LED Work Lights
- 24" Tool table work area
- Slug receptacles
- Electrical box supplied with emergency palm button and lock-out tag-out accommodations
- Complies with ANSI B 11.5 safety standards
- Forklift accommodations
- Three-year warranty on parts
- Made in USA





**DUAL OPERATOR**  
**5 STATIONS**

## DO 150/240-24M

### Capacities and Specifications

Rated On: A36 Mild Steel / 65,000 PSI Tensile

|   |  |
|---|--|
| <b>Punching Capacity</b>                    | 150 ton (136 mt)<br>1-7/8" in 1" (47 mm in 25 mm)<br>2-1/2" in 3/4" (64 mm in 19 mm) |
| <b>Special Tooling</b>                      | 4" (102 mm) Max. Dia.  |
| <b>Throat Depth</b>                         | 12" (305 mm)   |
| <b>Flat Bar Shear (sabre blade-std.)</b>    | 24" Length (610 mm)<br>1" x 14" (25 x 356 mm)<br>3/4" x 24" (19 x 610 mm)            |
| <b>Angle Shear 90°</b>                      | 6" x 6" x 1/2" (152 x 152 x 12 mm)   |
| <b>Angle Shear 45° w/Tool</b>               | 3" x 3" x 3/8" (76 x 76 x 10 mm)   |
| <b>w/Bar Shear</b>                          | 4" x 4" x 1/2" (102 x 102 x 12 mm)   |
| <b>Brake 12"</b>                            | 90 ton (81.6 mt)   |
| <b>Brake 24"</b>                            | 70 ton (63.5 mt)   |
| <b>Open End Brake</b>                       | Max. 1/4" x 5" (6 x 127 mm)<br>[Flat or Angle Iron]                                  |
| <b>Pipe Notcher Schedule 40</b>             | 3/4", 1", 1-1/4", 1-1/2", 2"   |
| <b>Rectangle Notcher</b>                    | 3" x 5-3/4" x 1/2" (76 x 146 x 12 mm)  |
| <b>90° V-Notcher</b>                        | 6" x 6" x 5/16" (152 x 152 x 8 mm)<br>3" x 3" x 1/2" (76 x 76 x 12 mm)               |
| <b>Notching in Leg of Channel</b>           | 6" to 10" (152 mm to 254 mm)   |
| <b>Channel Shear</b>                        | 2" to 6" adj. (51 mm to 152 mm adj.)   |
| <b>Unistrut Shear</b>                       | Samples Required   |
| <b>Rod Shear Round (max.)</b>               | 9 Cavity, 1/4" to 1-1/4" (6 mm to 32 mm)   |
| <b>Rod Shear Square (max.)</b>              | 1 Cavity, 1/4" to 1" (6 mm to 25 mm)   |
| <b>Square Tube Shear</b>                    | 1/2" to 2" (12 mm to 51 mm)<br>12 gauge (0.105" / 2.7 mm)                            |
| <b>Picket Tool</b>                          | 1/2", 3/4" & 1" (12 mm, 19 mm, 25 mm)<br>16 gauge (0.06" / 1.5 mm)                   |
| <b>Weld Coupon Bender (max.)</b>            | 2" wide x 3/8" (51 mm x 10 mm)   |
| <b>Offset Die Holder</b>                    | Max. 40 ton (36 mt)  |
| <b>Strokes per minute in light material</b> | 44 spm (1/4" stroke) [Punch Station]   |
| <b>Strokes per minute in heavy material</b> | 17 spm (3/4" stroke) [Punch Station]   |
| <b>Hydraulics</b>                           | 3,500/3,500 psi (241/241 bar)  |
| <b>Motor Options (must specify)</b>         | 10 hp 3 ph (7.46 kW) 208/230/460, 380/575v<br>10 hp 1 ph (7.46 kW) 220v              |
| <b>Dimensions</b>                           | L-83" (211 cm)<br>W-38-1/2" (98 cm)<br>H-77-1/4" (196.5 cm)                          |
| <b>Shipping Weight (may vary)</b>           | 6,404 lbs. (2,905 kg)  |

IRONWORKERS

### STANDARD FEATURES

- Dual operator allows for two operators to work at the same time at full capacity
- 150 ton punch station
- Keyed punch ram for safety
- Punch gauging table with fence and scale
- Die Holder complete with a 2" die insert
- Punch nut with wrench & stripper
- Adjustable swing-away stripper
- One round punch & die: max. diameter 1-1/4"
- Jog control
- Two electric remote foot pedals
- Two adjustable electric stroke controls with scale
- Tandem hydraulic pump
- Two valves
- Angle shear
- Rectangle notcher with table, scale and guides
- Flat bar shear with sabre blade
- Shear table with miter fence
- LED Work Lights
- 24" Tool table work area
- Slug receptacles
- Electrical box supplied with emergency palm button and lock-out tag-out accommodations
- Complies with ANSI B 11.5 safety standards
- Forklift accommodations
- Three-year warranty on parts
- Made in USA



# Ironworker *Optional Tooling*

IRONWORKERS

|    |  | PF 45      | 50514-EC         | 5014-ET      | 6509         | DO70         | DO85         | F185         | 9012         | DO95         | 12012        | DO120        | DO135        | DO150        |
|----|--|------------|------------------|--------------|--------------|--------------|--------------|--------------|--------------|--------------|--------------|--------------|--------------|--------------|
| A  | 6" Brake                                     | ●          | ●                | ●            |              |              |              |              |              |              |              |              |              |              |
| B  | 8" Brake                                     | ●          | ●                | ●            |              |              |              |              |              |              |              |              |              |              |
| C  | 12" Brake                                    | ●          | ●                | ●            | ●            | ●            | ●            | ●            | ●            | ●            | ●            | ●            | ●            | ●            |
| D  | 24" Brake                                    |            |                  |              | ●            | ●            | ●            | ●            | ●            | ●            | ●            | ●            | ●            | ●            |
| E  | Open End Brake                               | ●          | ●                | ●            | ●            | ●            | ●            | ●            | ●            | ●            | ●            | ●            | ●            | ●            |
| F  | Pipe Notcher                                 | ●          | ●                | ●            | ●            | ●            | ●            | ●            | ●            | ●            | ●            | ●            | ●            | ●            |
| G  | Rectangle Notcher                            | ●          |                  |              | ●            |              |              |              | ●            |              | ●            |              |              |              |
| H  | 90° V-Notcher                                | ●          | ●                | ●            | ●            | ●            | ●            | ●            | ●            | ●            | ●            | ●            | ●            | ●            |
| I  | Square Tube Shear                            | ●          | ●                | ●            | ●            | ●            | ●            | ●            | ●            | ●            | ●            | ●            | ●            | ●            |
| J  | Rod Shear                                    | ●          | ●                | ●            | ●            | ●            |              |              | ●            | ●            | ●            | ●            | ●            | ●            |
| K  | Unistrut Shear                               | ●          | ●                | ●            | ●            | ●            | ●            | ●            | ●            | ●            | ●            | ●            | ●            | ●            |
| L  | Weld Coupon Bender                           | ●          | ●                | ●            | ●            | ●            | ●            | ●            | ●            | ●            | ●            | ●            | ●            | ●            |
| M  | Picket Tool                                  | ●          | ●                | ●            | ●            | ●            | ●            | ●            | ●            | ●            | ●            | ●            | ●            | ●            |
| N  | Channel Shear                                |            |                  |              | ●            | ●            |              | ●            | ●            | ●            | ●            | ●            | ●            | ●            |
| O  | Channel Shear Blades                         |            |                  |              |              |              | ●            |              |              |              |              |              |              |              |
| P  | 6"x6" Die Holder                             |            |                  |              | ●            | ●            | ●            | ●            | ●            | ●            | ●            | ●            | ●            | ●            |
| Q  | Offset Die Holder                            |            |                  |              | ●            | ●            | ●            | ●            | ●            | ●            | ●            | ●            | ●            | ●            |
| R  | Urethane Stripper                            |            |                  |              | ●            | ●            | ●            | ●            | ●            | ●            | ●            | ●            | ●            | ●            |
| S  | Hydraulic Hold Down                          |            |                  |              | ●            |              |              | ●            | ●            | ●            | ●            | ●            | ●            | ●            |
| T  | 4" Angle Iron Miter Guide                    |            | ●                | ●            |              |              |              |              |              |              |              |              |              |              |
| U  | 6" Angle Iron Miter Guide                    |            |                  |              | ●            | ●            |              | ●            | ●            | ●            | ●            | ●            | ●            | ●            |
| V  | Optional Punch for Notcher End               |            |                  |              |              |              | ●            |              |              |              |              |              |              |              |
| W  | Open End Brake for Notcher End               |            |                  |              |              |              | ●            |              |              |              |              |              |              |              |
| X  | 30" Material Stop                            | ●          |                  |              |              |              |              |              |              |              |              |              |              |              |
| Y  | 48" Back Gauge                               |            | ●                | ●            | ●            | ●            | ●            | ●            | ●            | ●            | ●            | ●            | ●            | ●            |
| Z  | Brake Table w/ scale & squaring arm 12"      | ●          | ●                | ●            | ●            | ●            | ●            | ●            | ●            | ●            | ●            | ●            | ●            | ●            |
| Z  | Brake Table w/ scale & squaring arm 24"      |            |                  |              | ●            | ●            | ●            | ●            | ●            | ●            | ●            | ●            | ●            | ●            |
| Z  | Brake Length Gauge w/ scale 8"               | ●          | ●                | ●            |              |              |              |              |              |              |              |              |              |              |
| Z  | Brake Length Gauge w/ scale 12"              | ●          | ●                | ●            | ●            | ●            |              |              | ●            | ●            | ●            | ●            | ●            | ●            |
| Z  | Brake Length Gauge w/ scale 24"              |            |                  |              | ●            | ●            |              |              | ●            | ●            | ●            | ●            | ●            | ●            |
| AA | Shear Table w/ Miter Fence                   |            | ●                | ●            |              |              |              |              |              |              |              |              |              |              |
| BB | Punch Gauging Table w/ Fence & Scale         |            | ●                | ●            |              |              |              |              |              |              |              |              |              |              |
| CC | Unequal Leg Blades for Angle Shear           |            |                  |              | ●            | ●            |              |              | ●            | ●            | ●            | ●            | ●            | ●            |
| DD | Multi-Loc Punch Gauging Extension: 36" & 85" |            |                  |              | ●            | ●            | ●            | ●            | ●            | ●            | ●            | ●            | ●            | ●            |
| EE | Punch Table Extension                        |            |                  |              | ●            | ●            | ●            | ●            | ●            | ●            | ●            | ●            | ●            | ●            |
| FF | Tool table extension with punch & die drawer |            | ●                | ●            | ●            | ●            |              |              | ●            | ●            | ●            | ●            | ●            | ●            |
| GG | Laser Light (Shear)                          |            | ●                | ●            | ●            | ●            |              | ●            | ●            | ●            | ●            | ●            | ●            | ●            |
| HH | LED Lights                                   | Opt. ● (P) | Std. ● (P, S, N) | Std. ● (P&S) | Std. ● (P&S) | Std. ● (P&S) | Std. ● (P&S) | Std. ● (P&S) | Std. ● (P&S) | Std. ● (P&S) | Std. ● (P&S) | Std. ● (P&S) | Std. ● (P&S) | Std. ● (P&S) |
| II | LG Measuring Device                          |            | ●                | ●            | ●            | ●            |              |              | ●            | ●            | ●            | ●            | ●            | ●            |
| JJ | 24" x 5' Conveyor w/ angle iron support      |            | ●                | ●            | ●            | ●            | ●            | ●            | ●            | ●            | ●            | ●            | ●            | ●            |
|    | Jog Control (Not Pictured)                   |            | ●                | ●            | Std.         | Std.         | Std.         | Std.         | Std.         | Std.         | Std.         | Std.         | Std.         | Std.         |

Standard Feature = Std. Optional Feature = Opt.

LED Light Locations: ●Punch ●Punch & Shear ●Punch, Shear & Notch

# Ironworker *Optional Tooling*

IRONWORKERS



6" Brake (A)



8" Brake (B)



12" Brake (C)



24" Brake (D)

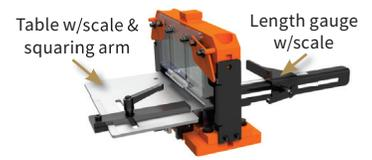

Brake Options (Z)  
(sold separately)



Open End Brake (E)



Pipe Notcher (F)



Rectangle Notcher (G)



90° V-Notcher (H)

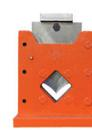

Square Tube Shear (I)



Rod Shear (J)



Unistrut Shear (K)



Weld Coupon Bender (L)



Picket Tool (M)

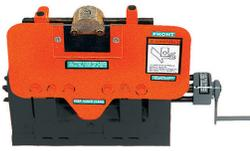

Channel Shear (N)



Channel Shear Blades (O)  
(DO85 only)



6" x 6" Die Holder (P)



Offset Die Holder (Q)



Urethane Stripper (R)



Hydraulic Hold Down (S)



4" Angle Iron Miter Guide (T)



6" Angle Iron Miter Guide (U)



Optional Punch for Notcher End (V)  
(DO85 only)

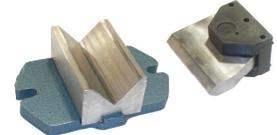

Open End Brake for Notcher End (W)  
(DO85 only)



30" Material Stop (X)



48" Back Gauge (Y)



Shear Table w/ Miter Fence (AA)



Punch Gauging Table w/ Fence & Scale (BB)



Unequal Leg Blades for Angle Shear (CC)  
66°, 70°, 74°, or 80°



Multi-Loc Punch Gauging Extension: 36" & 85" (DD)



Punch Table Extension (EE)



Tool table extension with punch & die drawer (FF)



Laser Light (GG)



LED Lights (HH)



LG Measuring Device (II)  
(add'l. tool info see page 44)



24" x 5' conveyor with angle iron support (JJ)  
← (attached to DO 70)  
(attached to 5014-ET) →



## CUSTOMIZED TOOLING FOR A CUSTOM SOLUTION.

### SOMETIMES, A UNIQUE APPLICATION REQUIRES A CUSTOM-BUILT SOLUTION.

If you need something beyond the standard tooling we offer, our team of engineers is equipped to design and build a tailored solution built to your specifications.

From our plant in Philip, South Dakota, each step of this process from design and development to completion is done in-house.

We thoroughly test each tool to verify performance and ensure value for your investment. With quality manufactured into every tool, we assure that our tools will stand up to the tough demands of your applications.



### Examples of Special Applications We've Built Tooling For

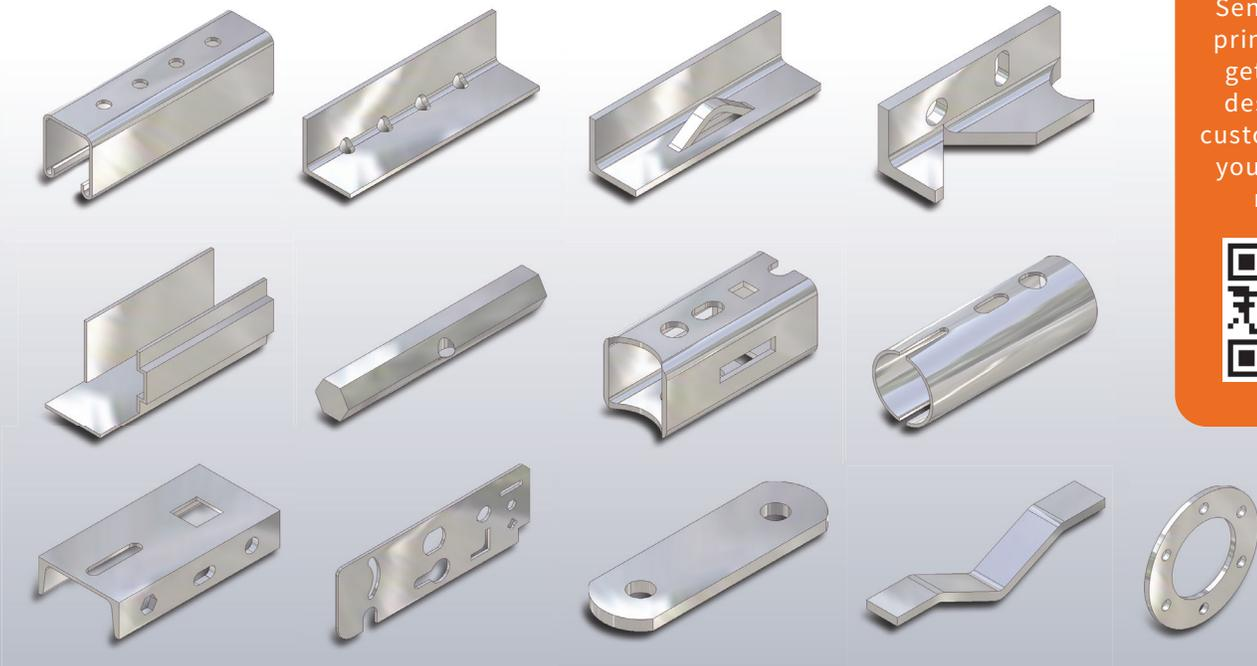

Send us your prints & we'll get to work designing a custom tool for your specific needs.



# In-Stock *Punches & Dies*

IRONWORKERS

| #20 & #40 Rounds |        |
|------------------|--------|
| 1/8              | 11/16  |
| 5/32             | 23/32  |
| 3/16             | 3/4    |
| 13/64            | 25/32  |
| 7/32             | 13/16  |
| 1/4              | 27/32  |
| 17/64            | 7/8    |
| 9/32             | 29/32  |
| 5/16             | 15/16  |
| 11/32            | 31/32  |
| 3/8              | 1      |
| 13/32            | 1-1/32 |
| 7/16             | 1-1/16 |
| 15/32            | 1-3/32 |
| 1/2              | 1-1/8  |
| 17/32            | 1-5/32 |
| 9/16             | 1-3/16 |
| 19/32            | 1-7/32 |
| 5/8              | 1-1/4  |
| 21/32            |        |

| Round Metric |       |
|--------------|-------|
| 5 mm         | 19 mm |
| 6 mm         | 20 mm |
| 7 mm         | 21 mm |
| 8 mm         | 22 mm |
| 9 mm         | 23 mm |
| 10 mm        | 24 mm |
| 11 mm        | 25 mm |
| 12 mm        | 26 mm |
| 13 mm        | 27 mm |
| 14 mm        | 28 mm |
| 15 mm        | 29 mm |
| 16 mm        | 30 mm |
| 17 mm        | 31 mm |
| 18 mm        | 32 mm |

| #49 Round Punches |         |
|-------------------|---------|
| 1-5/8             | 1-7/8   |
| 1-11/16           | 1-15/16 |
| 1-3/4             | 2       |
| 1-13/16           |         |

| Round Offset Dies |
|-------------------|
| 9/32              |
| 5/16              |
| 11/32             |
| 3/8               |
| 13/32             |
| 7/16              |
| 15/32             |
| 1/2               |
| 17/32             |
| 9/16              |
| 19/32             |

| #45 Round Punches |
|-------------------|
| 1-9/32            |
| 1-5/16            |
| 1-11/32           |
| 1-3/8             |
| 1-13/32           |
| 1-7/16            |
| 1-15/32           |
| 1-1/2             |
| 1-17/32           |
| 1-9/16            |

| Split Ring Round |
|------------------|
| 1-5/8            |
| 1-3/4            |
| 2                |
| 2-1/4            |
| 2-1/2            |
| 2-3/4            |
| 3                |

| Ovals       |               |
|-------------|---------------|
| 1/4 x 1/2   | 3/4 x 1       |
| 9/32 x 1/2  | 25/32 x 1     |
| 1/4 x 3/4   | 13/16 x 1     |
| 9/32 x 3/4  | 7/8 x 1       |
| 5/16 x 3/4  | 15/16 x 1     |
| 11/32 x 3/4 | 1/4 x 1-1/4   |
| 3/8 x 3/4   | 9/32 x 1-1/4  |
| 13/32 x 3/4 | 5/16 x 1-1/4  |
| 7/16 x 3/4  | 11/32 x 1-1/4 |
| 15/32 x 3/4 | 3/8 x 1-1/4   |
| 1/2 x 3/4   | 13/32 x 1-1/4 |
| 17/32 x 3/4 | 7/16 x 1-1/4  |
| 9/16 x 3/4  | 15/32 x 1-1/4 |
| 19/32 x 3/4 | 1/2 x 1-1/4   |
| 5/8 x 3/4   | 17/32 x 1-1/4 |
| 1/4 x 1     | 9/16 x 1-1/4  |
| 9/32 x 1    | 19/32 x 1-1/4 |
| 5/16 x 1    | 5/8 x 1-1/4   |
| 11/32 x 1   | 21/32 x 1-1/4 |
| 3/8 x 1     | 11/16 x 1-1/4 |
| 13/32 x 1   | 23/32 x 1-1/4 |
| 7/16 x 1    | 3/4 x 1-1/4   |
| 15/32 x 1   | 25/32 x 1-1/4 |
| 1/2 x 1     | 13/16 x 1-1/4 |
| 17/32 x 1   | 7/8 x 1-1/4   |
| 9/16 x 1    | 15/16 x 1-1/4 |
| 19/32 x 1   | 7/16 x 1-1/2  |
| 5/8 x 1     | 9/16 x 1-1/2  |
| 21/32 x 1   | 11/16 x 1-1/2 |
| 11/16 x 1   | 13/16 x 1-1/2 |
| 23/32 x 1   | 15/16 x 1-1/2 |

| Squares |
|---------|
| 1/4     |
| 9/32    |
| 5/16    |
| 11/32   |
| 3/8     |
| 13/32   |
| 7/16    |
| 15/32   |
| 1/2     |
| 17/32   |
| 9/16    |
| 19/32   |
| 5/8     |
| 21/32   |
| 11/16   |
| 23/32   |
| 3/4     |
| 25/32   |
| 13/16   |
| 27/32   |
| 7/8     |
| 29/32   |
| 15/16   |
| 31/32   |
| 1       |
| 1-1/32  |

| Hexagon |
|---------|
| 7/16    |
| 1/2     |
| 11/16   |
| 3/4     |

| Corner Turning |
|----------------|
| 1/2            |
| 3/4            |

| Trimming & Cut Off |
|--------------------|
| 3/4                |
| 1                  |

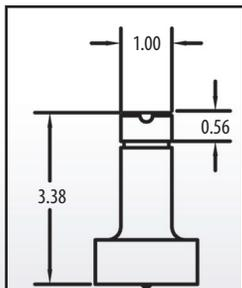

**#20 Punch**  
1/8" Thru 1-1/4"  
5 mm Thru 32 mm

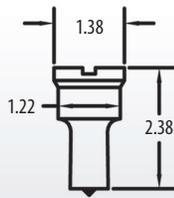

**#40 Punch**  
1/8" Thru 1-1/4"  
5 mm Thru 32 mm

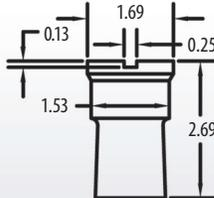

**#45 Punch**  
1-9/32" Thru 1-9/16"

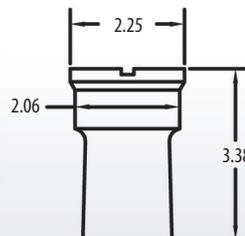

**#49 Punch**  
12012, D0120, DO135,  
DO150 Machine Only  
1-5/8" Thru 2"

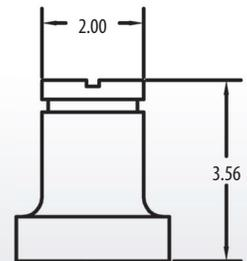

**Split Ring Punch**  
1-5/8" Thru 3"

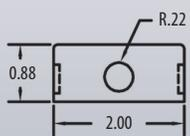

**#20 Die**

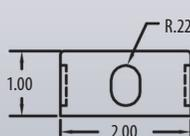

**#82 Die**

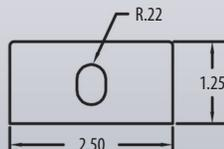

**#86 Die**

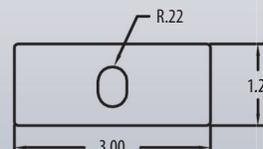

**3" Die**



**6 x 6 Die**

# Production Shear

SHEAR



Roller Conveyor optional

Designed with the high production end-user in mind, this machine combines a large capacity and fast cycle times turning it into a high production shear.

## STANDARD FEATURES

- 24" flat bar shear with 4-way reversible blades
- Shear table with miter fence
- Hydraulic hold-down
- Electric back gauge
- Electric stroke control
- Electric foot pedal
- LED Work Lights
- Two-stage hydraulic pump
- Electrical box supplied with emergency palm button and lock-out tag-out accommodations
- Complies with ANSI B 11.5 safety standards
- Forklift accommodations
- Three-year warranty on parts
- Made in USA

## OPTIONAL EQUIPMENT

- 10hp, 1ph Motor
- Infeed Conveyor (24" x 5')

## SHEARMASTER 610

### Capacities and Specifications

Rated On: A36 Mild Steel / 65,000 PSI Tensile

|                                     |  |
|-------------------------------------|--|
| <b>Shearing Capacity</b>            | 1" x 12" (25 x 305 mm)<br>3/4" x 16" (19 x 406 mm)<br>1/2" x 24" (12 x 610 mm) |
| <b>Strokes Per Minute</b>           | Full stroke—10, Half stroke—17   |
| <b>Motor Options (must specify)</b> | 10 hp (7.46 kW)<br>3ph, 230/460v<br>1ph, 220v                                  |
| <b>Length</b>                       | 49" (124.5 cm)   |
| <b>Width</b>                        | 37-3/4" (96 cm)  |
| <b>Height</b>                       | 70" (178 cm)   |
| <b>Shipping Weight (may vary)</b>   | 3,065 lbs. (1,390 kg)  |



# Utility Band Saw



For larger material that requires a band saw, this scaled-down but rugged horizontal band saw can easily cut through round material up to 8" diameter, & features a swing head that can miter 60° right of 90°, giving you a 30° cut part without material movement.

BAND SAW



Optional Conveyor and measuring devices available

## STANDARD FEATURES

- Quick action locking vise
- Miter Capability 60° right of 90°
- Blade trigger switch
- Gravity feed with adjustable down-feed pressure
- Blade tension gauge
- Carbide blade guides with roller supports
- Re-circulating coolant system
- Band door interlocks
- One saw blade
- One gallon coolant
- Meets CE standards
- Three-year warranty on parts
- Made in Spain

## OPTIONAL EQUIPMENT

- Conveyor (10' and 20')
- Manual or digital measuring system (see pages 43-44)

## SU-280 G

### SPECIFICATIONS

|                              |  |
|------------------------------|--|
| Blade Length                 | 1" x 96.5"                                 |
| Two Cutting Speeds           | 131/262 FPM (3 phase machines)             |
| One Cutting Speed            | 196 FPM (1 phase machines)                 |
| Motor Options (must specify) | 1.3 hp (1kW)<br>3ph, 230/460v<br>1ph, 220v |
| Width                        | 33-1/2" (85 cm)                            |
| Depth                        | 55" (140 cm)                               |
| Height                       | 69" (175 cm)                               |
| Shipping Weight (may vary)   | 650 lbs. (295 kg)                          |



### MAXIMUM CAPACITIES

| Tubing    | 90 Degree                   | 45 Degree                  | 60 Degree                  |
|-----------|-----------------------------|----------------------------|----------------------------|
| Round     | 8" (203 mm)                 | 7" (178 mm)                | 4-1/4" (108 mm)            |
| Square    | 8" (203 mm)                 | 6-1/4" (159 mm)            | 4" (102 mm)                |
| Rectangle | 11" x 7-3/4" (279 x 197 mm) | 7" x 6-1/4" (178 x 159 mm) | 4-1/4" x 4" (108 x 102 mm) |

# Cold Saws

COLD SAWS



## Manual to Fully Automatic Circular Cold Saws For Ferrous & Non-Ferrous Materials

A Circular Cold Cut Saw is the best machine for cutting ferrous and non-ferrous metals. For mild steel and other ferrous materials, this unique type of cutting turns the blade at a very low RPM, similar to a milling process, giving a FAST, precise, burr-free cut without heat or sparks.

The Scotchman Cold Saw line is complete with both ferrous and non-ferrous models, manual to fully automatic, and is capable of cutting straight or angled cuts.

Scotchman also offers a complete selection of cold saw blades in stock for immediate delivery. Our in-house blade sharpening service provides high-quality and consistent results with a quick turnaround time.



COLD SAWS

|  |       |
|--|-------|
| <b>MANUAL TO SEMI-AUTOMATIC</b>                          |       |
| CPO 350 SERIES<br>PIVOT STYLE SAW.....                   | 29-30 |
| CPO 275 SERIES<br>PIVOT STYLE SAW.....                   | 31    |
| OPTIONS AND ACCESSORIES<br>FOR CPO 350 & 275.....        | 32    |
| <b>AUTOMATIC</b>   |       |
| HITCH FEED AUTOMATIC (HFA)<br>PIVOT STYLE 90° SAW.....   | 33-34 |
| ROLLER FEED AUTOMATIC (RFA)<br>PIVOT STYLE 90° SAW.....  | 35    |
| AUTOLOADER<br>PIVOT STYLE AUTOMATIC SAW .....            | 36    |
| SUP SERIES - (500 & 600)<br>UPCUT STYLE MITER SAW .....  | 37-38 |
| GAA SERIES - (500 & 600)<br>UPCUT STYLE 90° SAW .....    | 39-40 |
| <b>SAW BLADES, OPTIONAL EQUIPMENT &amp; SERVICES ...</b> |       |
| 41-42  |       |

# Cold Saws *CPO 350 Series*

Steel & Ferrous metal cutting

COLD SAWS

## CPO 350

### MANUAL SAW

- Manual clamp for material vise
- Operator controlled trigger switch



## CPO 350 PK

### MANUAL SAW W/POWER CLAMP

- Air-operated clamp for material vise
- Operator controlled trigger switch



## CPO 350 PKPD

### SEMI-AUTOMATIC SAW

- Air-operated clamp for material vise
- Pneumatic power down feed with electric controls
- Emergency stop button



### STANDARD FEATURES

- Double self-centering vise assures burr-free cuts
- Miter capabilities 45° left to 45° right
- Miter locking device: quick, accurate setting-stops at 45° left, 90° & 45° right
- Capable of slotting
- Two cutting speeds
- Double reduction, hardened bronze gears
- Chip drawer
- Seven-gallon flood coolant tank with pump
- One HSS blade
- One gallon coolant
- Complies with ANSI B 11.10 safety standards
- Three-year warranty on parts
- Made in USA

### MAXIMUM CAPACITIES

(with a 350 mm blade)

| Tubing    | 90 Degree                      | 45 Degree                    |
|-----------|--------------------------------|------------------------------|
| Round     | 4-1/2" (114 mm)                | 4" (102 mm)                  |
| Square    | 4-1/4" x 4-1/4" (108 x 108 mm) | 3-3/4" x 3-3/4" (95 x 95 mm) |
| Rectangle | 5-1/2" x 4" (140 x 102 mm)     | 3-3/4" x 3-3/4" (95 x 95 mm) |
| Solid     | 90 Degree                      | 45 Degree                    |
| Round     | 1-3/4" (44 mm)                 | 1-1/2" (38 mm)               |
| Square    | 1-3/4" x 1-3/4" (44 x 44 mm)   | 1-1/2" x 1-1/2" (38 x 38 mm) |

### SPECIFICATIONS

|                                |   |
|--------------------------------|---|
| Motor Options (must specify)   | LT & HT- 208/230/460/575v, 3ph; 220v, 1ph<br>VS- 230/460v, 3ph; 220v, 1ph<br>SS- 220v, 1ph    |
| Air Pressure                   | 90 psi (PK and PKPD. N/A on CPO 350)  |
| Maximum Diameter Blade         | 350 mm  |
| Arbor Bore                     | 40 mm   |
| Pin Spacing                    | 4/12/64   |
| Width                          | 21-7/8" (55.5 cm)   |
| Depth                          | 43-1/2" (110.5 cm)  |
| Height (not incl. feed handle) | 56-1/4" (143 cm)  |
| Height (floor to vise)         | 36.8" (93.47 cm)  |
| Shipping Weight (may vary)     | CPO 350 660 lbs. (299 kg)<br>CPO 350 PK: 690 lbs. (313 kg)<br>CPO 350 PKPD: 760 lbs. (345 kg) |

### CUTTING SPEEDS

(must specify)

|  |                                 |
|--|---------------------------------|
| LT (Low Turn)<br>designed for solid mild & stainless steel, & thick wall pipe.                         | LT 22/44 rpm, 3hp (2.24 kW)     |
| HT (High Turn)<br>designed for thin wall tube 0.060 wall thickness or thinner and non-ferrous material | HT 44/88 rpm , 3hp (2.24 kW)    |
| VS (Variable Speed)  | VS 11 to 177 rpm, 5hp (3.73 kW) |
| SS (Single Speed)  | SS 44 rpm, 3hp (2.24 kW)        |



# Cold Saws

## CPO 350 NF Series

Aluminum, Non-Ferrous Metals & Plastic Cutting

### CPO 350 NF

#### MANUAL SAW

- Manual clamp for material vise
- Operator controlled trigger switch



### CPO 350 NF PK

#### MANUAL SAW W/POWER CLAMP

- Air-operated clamp for material vise
- Operator controlled trigger switch



### CPO 350 NF PKPD

#### SEMI-AUTOMATIC SAW

- Air-operated clamp for material vise
- Pneumatic power down feed with electric controls
- Emergency stop button



COLD SAWS

#### STANDARD FEATURES

- Double self-centering vise assures burr-free cuts
- Miter capabilities 45° left to 45° right
- Miter locking device: quick, accurate setting-stops at 45° left, 90°, & 45° right
- Capable of slotting
- Positive-driven cogged belt system
- Chip drawer
- Mist coolant lubrication system
- One carbide tipped blade
- One gallon coolant
- Complies with ANSI B 11.10 safety standards
- Three-year warranty on parts
- Made in USA

#### MAXIMUM CAPACITIES

(with a 350 mm blade)

| Tubing       | 90 Degree                      | 45 Degree                    |
|--------------|--------------------------------|------------------------------|
| Round        | 4-1/2" (114 mm)                | 4-1/4" (108 mm)              |
| Square       | 4-1/4" x 4-1/4" (108 x 108 mm) | 4" x 4" (102 x 102 mm)       |
| Rectangle    | 5-1/2" x 4" (140 x 102 mm)     | 4" x 4" (102 x 102 mm)       |
| <b>Solid</b> | <b>90 Degree</b>               | <b>45 Degree</b>             |
| Round        | 3" (76 mm)                     | 2-1/2" (64 mm)               |
| Square       | 3" x 3" (76 x 76 mm)           | 2-1/2" x 2-1/2" (64 x 64 mm) |

#### SPECIFICATIONS

|                                |  |
|--------------------------------|--|
| Motor Options (must specify)   | 208/230/460v, 3ph  |
| Air Pressure                   | 90 psi   |
| Maximum Diameter Blade         | 350 mm   |
| Arbor Bore                     | 40 mm  |
| Pin Spacing                    | 4/12/64  |
| Width                          | 21-7/8" (55.5 cm)  |
| Depth                          | 43-1/2" (110.5 cm)   |
| Height (not incl. feed handle) | 56-1/4" (143 cm)   |
| Height (floor to vise)         | 36.8" (93.47 cm)   |
| Shipping Weight (may vary)     | CPO 350 NF: 625 lbs. (283 kg)<br>CPO 350 NF/PK: 655 lbs. (297 kg)<br>CPO 350 NF PK/PD: 725 lbs. (329 kg) |

#### CUTTING SPEEDS

|                            |                           |
|----------------------------|---------------------------|
| Non-Ferrous Cutting Speeds | 3,000 rpm, 5 hp (1.49 kW) |
|----------------------------|---------------------------|



# Cold Saws *CPO 275 Series*

Steel & Ferrous metal cutting

## CPO 275

### MANUAL SAW

- Manual clamp for material vise
- Operator controlled trigger switch



## CPO 275 PK

### MANUAL SAW W/ POWER CLAMP

- Air-operated clamp for material vise
- Operator controlled trigger switch



## CPO 275 PKPD

### SEMI-AUTOMATIC SAW

- Air-operated clamp for material vise
- Pneumatic power down feed with electric controls
- Emergency stop button



### STANDARD FEATURES

- Double self-centering vise assures burr-free cuts
- Miter locking device stops 45° left, 90° and 45° right (Not available on PK or PKPD models)
- Capable of slotting
- Two cutting speeds
- Double reduction, hardened bronze gears
- Chip drawer
- Seven-gallon flood coolant tank with pump
- One HSS blade
- One gallon coolant
- Complies with ANSI B 11.10 safety standards
- Three-year warranty on parts
- Made in USA

### MAXIMUM CAPACITIES

(with a 275 mm blade)

| Tubing    | 90 Degree                    | 45 Degree            |
|-----------|------------------------------|----------------------|
| Round     | 3-3/8" (86 mm)               | 2" (51 mm)           |
| Square    | 3" x 3" (76 x 76 mm)         | 2" x 2" (51 x 51 mm) |
| Rectangle | 3" x 2-3/8" (76 x 60 mm)     | 2" x 2" (51 x 51 mm) |
| Solid     | 90 Degree                    | 45 Degree            |
| Round     | 1-1/2" (38 mm)               | 1" (25 mm)           |
| Square    | 1-1/2" x 1-1/2" (38 x 38 mm) | 1" x 1" (25 x 25 mm) |

### SPECIFICATIONS

|                                |  |
|--------------------------------|--|
| Motor Options (must specify)   | LT & HT: 208/230/460/575v, 3ph<br>SS: 220v, 1ph  |
| Air Pressure                   | 90 psi<br>(PK and PKPD Only, n/a on CPO 275)   |
| Maximum Diameter Blade         | 275 mm   |
| Arbor Bore                     | 32 mm  |
| Pin Spacing                    | 2/8/45   |
| Width                          | 21-7/8" (55.5 cm)  |
| Depth                          | 43-1/2" (110.5 cm)   |
| Height (not incl. feed handle) | 53-1/4" (135 cm)   |
| Height (floor to vise)         | 36-1/8" (92 cm)  |
| Shipping Weight (may vary)     | CPO 275: 550 lbs. (249 kg)<br>CPO 275 PK: 580 lbs. (263 kg)<br>CPO 275 PKPD: 670 lbs. (304 kg) |

### CUTTING SPEEDS

(must specify)

|  |                                |
|--|--------------------------------|
| LT (Low Turn)<br>designed for solid mild & stainless steel, & thick wall pipe.                         | LT 30/60 rpm, 2hp (1.49 kW)    |
| HT (High Turn)<br>designed for thin wall tube 0.060 wall thickness or thinner and non-ferrous material | HT 60/120 rpm, 1.5hp (1.12 kW) |
| SS (Single Speed)  | SS 60 rpm, 2hp (1.49 kW)       |



# Cold Saw Options

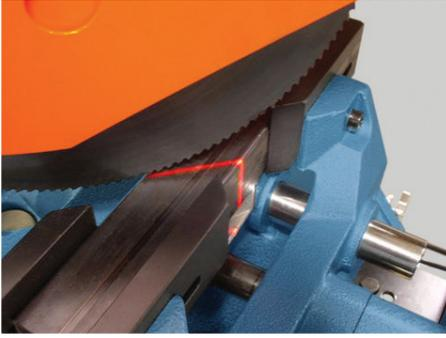

**Blade Guide Laser Light**  
(Not Available on 275 series)

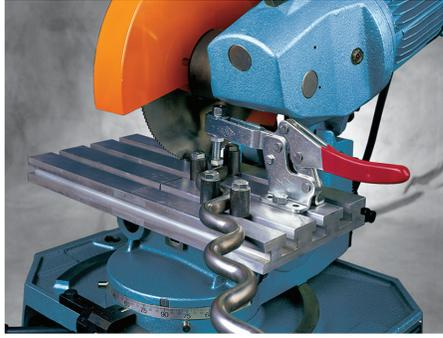

**Universal Clamping Fixture**

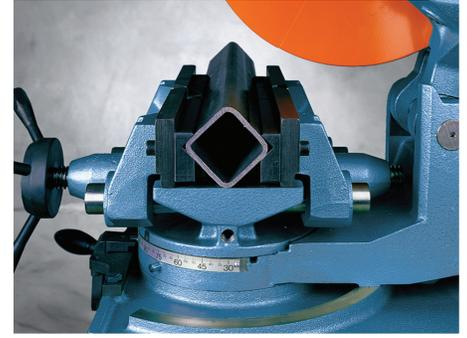

**Square Tube/Diagonal Vise Jaws**  
(Not Available on NF series)



**Variable Speed Control**  
(Not Available on NF or 275 series)

Recommended for cutting multiple shapes, sizes, and thicknesses. RPM can be fine-tuned to achieve optimum blade speed for each application and extend blade life.

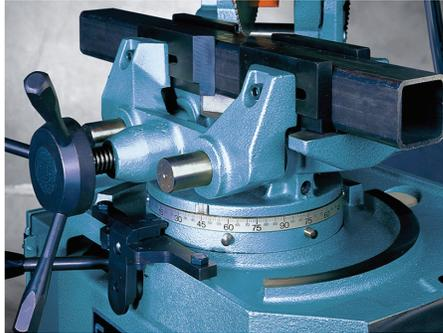

**Miter Locking Device**  
**Standard Feature**

(not available for 275 PK or 275 PKPD models)



**Saw Blades**  
(See page 41)

COLD SAWS



**Roller Conveyor**

**Roller Conveyor (w/Quick-Loc measuring)**

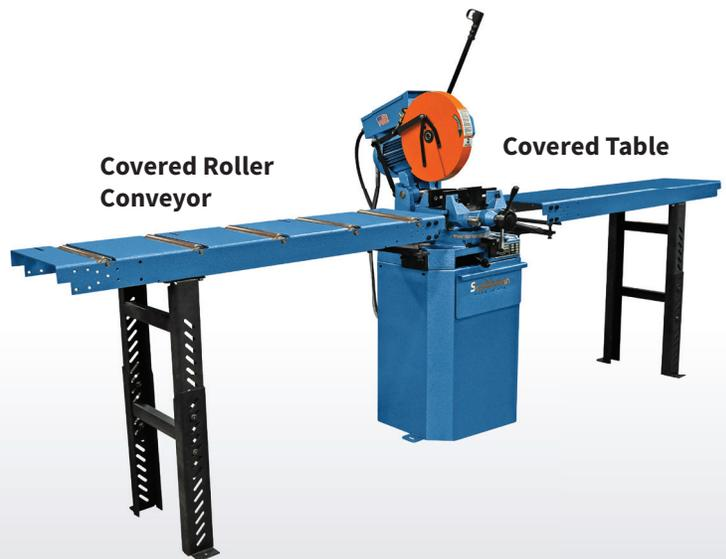

**Covered Roller Conveyor**

**Covered Table**

## Automate your saw

Measuring devices available from manual to fully automatic.

(See pages 43-46)



# Hitch Feed Automatic

COLD SAWS



Ideal for high volume and short length applications that require very accurate and clean cuts; this Hitch Feed Automatic (HFA) cold saw is fully automatic and provides uninterrupted cutting on tubing or solids.

## STANDARD FEATURES

- Available in ferrous & non-ferrous
- Fully automatic cycle
- Push button controls
- Interlocking safety hood
- Emergency stop button
- Clamping both sides of blade - highest quality, burr-free cuts
- Blade guides for accurate tolerances (ferrous model)
- Mist coolant lubrication system
- Adjustable stroke control
- Adjustable down feed control on the saw head for feed rate
- Length scale in both inches and metric
- Quick and easy fine adjustment of length setting
- 30" single length shuttle
- Three shuttle max
- Piece counter
- One gallon coolant
- Complies with ANSI B 11.10 safety standards
- Two-year warranty on parts
- Made in USA

## CPO 315 HFA

### SPECIFICATIONS

|                              |  |
|------------------------------|--|
| Length Tolerance             | ±0.006" per index  |
| Squareness Tolerance         | ±0.002" per diameter inch                                |
| Minimum Cut Length           | 1/8" (3 mm)  |
| Maximum Cut Length           | Single Index 30"<br>Double Index 60"<br>Triple Index 90" |
| Motor Options (must specify) | 208/230/460v, 3ph  |
| Air Pressure                 | 90 psi   |
| Maximum Diameter Blade       | 315 mm   |
| Arbor Bore Size              | 40 mm  |
| Pin Spacing                  | 4/12/64  |
| Length                       | 100" (254 cm)  |
| Width                        | 44" (112 cm)   |
| Height                       | 64" (162.5 cm)   |
| Shipping Weight (may vary)   | 1,800 lbs. (816.5 kg)                                    |

## OPTIONAL EQUIPMENT

- Flood coolant
- Form jaws for multiple tubes
- Digital read-out for quick easy length setting
- Ten-foot or twenty-foot material supply track

## CUTTING SPEEDS

|                              |  |
|------------------------------|--|
| CPO 315 HFA (Ferrous)        | Variable Speed 11 to 177 rpm<br>5 hp (3.73 kW) |
| CPO 315 HFA NF (Non-Ferrous) | 3,000 rpm<br>5 hp (3.73 kW)                    |

## MAXIMUM CAPACITIES

(with a 315 mm blade)

| Tubing            |                                |
|-------------------|--------------------------------|
| Round             | 3-1/2" (≤ 89 mm)               |
| Square            | 3" x 3" (≤ 76 x 76 mm)         |
| Solid             |                                |
| Round             | 1-3/4" (≤ 45 mm)               |
| Square            | 1-1/2" x 1-1/2" (≤ 38 x 38 mm) |
| Solid (NF Models) |                                |
| Round             | 3-1/2" (≤ 89 mm)               |
| Square            | 3" x 3" (≤ 76 x 76 mm)         |



# Hitch Feed Automatic CNC



This fully automatic CNC saw allows for unlimited length settings; plus, the first piece cut is *always* accurate.

Easily program a quantity of pieces cut to a specific length OR program up to four separate lengths & part quantities to be cut in sequence.

COLD SAWS

## CPO 315 HFA CNC

### STANDARD FEATURES

- Available in ferrous & non-ferrous
- Fully automatic cycle
- Touch screen controls
- Precision CNC controlled
- Interlocking safety hood
- Emergency stop button
- Clamping both sides of blade - highest quality, burr-free cuts
- Blade guides for accurate tolerances (ferrous model)
- Mist coolant lubrication system
- Adjustable stroke control
- Adjustable down feed control on the saw head for feed rate
- Adjustable indexing feed speeds
- Program up to four separate cut lengths in each job
- 100 program job storage
- 30" single length shuttle
- Unlimited shuttles
- Piece counter
- One saw blade
- One gallon coolant
- Complies with ANSI B 11.10 safety standards
- Two-year warranty on parts
- Made in USA

### SPECIFICATIONS

|                              |                           |
|------------------------------|---------------------------|
| Length Tolerance             | ±0.006" per index         |
| Squareness Tolerance         | ±0.002" per diameter inch |
| Minimum Cut Length           | 1/8" (3 mm)               |
| Maximum Cut Length           | unlimited                 |
| Motor Options (must specify) | 208/230/460v, 3ph         |
| Air Pressure                 | 90 psi                    |
| Maximum Diameter Blade       | 315 mm                    |
| Arbor Bore Size              | 40 mm                     |
| Pin Spacing                  | 4/12/64                   |
| Length                       | 100" (254 cm)             |
| Width                        | 44" (112 cm)              |
| Height                       | 64" (162.5 cm)            |
| Shipping Weight (may vary)   | 1,800 lbs. (816.5 kg)     |

### OPTIONAL EQUIPMENT

- Flood coolant
- Form jaws for multiple tubes
- Ten-foot or twenty-foot material supply track

### CUTTING SPEEDS

|                              |  |
|------------------------------|--|
| CPO 315 HFA (Ferrous)        | Variable Speed 11 to 177 rpm<br>5 hp (3.73 kW) |
| CPO 315 HFA NF (Non-Ferrous) | 3,000 rpm<br>5 hp (3.73 kW)                    |

### MAXIMUM CAPACITIES

(with a 315 mm blade)

| Tubing            |                                |
|-------------------|--------------------------------|
| Round             | 3-1/2" (≤ 89 mm)               |
| Square            | 3" x 3" (≤ 76 x 76 mm)         |
| Solid             |                                |
| Round             | 1-3/4" (≤ 45 mm)               |
| Square            | 1-1/2" x 1-1/2" (≤ 38 x 38 mm) |
| Solid (NF Models) |                                |
| Round             | 3-1/2" (≤ 89 mm)               |
| Square            | 3" x 3" (≤ 76 x 76 mm)         |



# Roller Feed Automatic *CPO 315 RFA*

Ideal for high volume and long length applications that require very accurate and clean cuts; this Roller Feed Automatic (RFA) cold saw is fully automatic, can store profile settings such as speeds and feeds, and is designed to your specifications.



(RFA shown with Supply Table)



Optional Bundle Loading Magazine

COLD SAWS

## STANDARD FEATURES

- Available in ferrous and non-ferrous
- Fully automatic cycle
- Touch screen controls
- Interlocking safety hood
- Emergency stop button
- Automatic loading and trim cut of each new bar
- Automatic tube ejection
- Trim and remnant gate
- Clamping both sides of blade - highest quality, burr-free cuts
- Blade guides for accurate tolerances (ferrous model)
- Adjustable stroke control on the saw head
- Adjustable downfeed control on saw head for feed rate
- Length scale in both inches and metric
- Digital read-out for quick and easy fine adjustment of length setting
- Piece counter
- Mist coolant lubrication system
- One saw blade
- One gallon coolant
- Complies with ANSI B 11.10 safety standards
- Two-year warranty on parts
- Made in USA

## OPTIONAL EQUIPMENT

- In-line deburring unit
- Flood coolant
- Longer cut lengths - 90" or 120"
- Bundle loader magazine

## MAXIMUM CAPACITIES

(with a 315 mm blade)

| Tubing            |                              |
|-------------------|------------------------------|
| Round             | 3" (76 mm)                   |
| Square            | 2-1/2" x 2-1/2" (64 x 64 mm) |
| Solid             |                              |
| Round             | 1-3/4" (44 mm)               |
| Square            | 1-1/2" x 1-1/2" (38 x 38 mm) |
| Solid (NF Models) |                              |
| Round             | 3" (76 mm)                   |
| Square            | 2-1/2" x 2-1/2" (64 x 64 mm) |



## SPECIFICATIONS

|                              |                               |                          |
|------------------------------|-------------------------------|--------------------------|
| Length Tolerance             | ±0.006" repeatability         |                          |
| Squareness Tolerance         | ±0.002" per diameter inch     |                          |
| Minimum Cut Length           | 1-1/4" (32 mm)                |                          |
| Maximum Cut Length           | 60" (90" or 120" available)   |                          |
| Minimum Trim Cut             | 1" (25 mm)                    |                          |
| Motor Options (must specify) | 208/230/460v, 3ph             |                          |
| Air Pressure                 | 90 psi                        |                          |
| Maximum Diameter Blade       | 315 mm                        |                          |
| Arbor Bore Size              | 40 mm                         |                          |
| Pin Spacing                  | 4/12/64                       |                          |
| 12' Supply Table (ST)        | Maximum Raw Stock (12' ST)    | 12'                      |
|                              | Load Table Capacity           | 24"                      |
|                              | Dimensions - 12' ST w/60" Saw | (L) 240" (W) 48" (H) 60" |
| 24' Supply Table (ST)        | Maximum Raw Stock (24' ST)    | 24'                      |
|                              | Load Table Capacity           | 24"                      |
|                              | Dimensions - 24' ST w/60" Saw | (L) 380" (W) 48" (H) 60" |
| Bundle Loader (BL)           | Maximum Raw Stock (BL)        | Up to 24'                |
|                              | Load Table Capacity           | 4,000 lbs                |
|                              | Dimensions - 24' BL w/60" Saw | (L) 384" (W) 93" (H) 60" |

## CUTTING SPEEDS

|                                 |  |
|---------------------------------|--|
| CPO 315 RFA/ST (Ferrous)        | Variable Speed 11 to 177 rpm<br>5 hp (3.73 kW) |
| CPO 315 RFA/ST NF (Non-Ferrous) | 3,000 rpm<br>5 hp (3.73 kW)                    |

# CPO 350 AutoLoader

The CPO 350 AutoLoader is a fully automatic sawing system guaranteed to save time, eliminate costly mistakes, and deliver consistent results for years to come. Quick set-up, automatic part length change, and the fast reloading of material adds efficiency.



## STANDARD FEATURES

- Available in ferrous and non-ferrous
- Fully automatic cycle or semi-automatic operation
- Pneumatic power down feed with electric controls
- Adjustable stroke control
- Adjustable down feed control on saw head for feed rate
- Air operated material vise clamp
- Clamping on both sides of the blade
- Fixed rear vise
- Double reduction, hardened bronze gears (ferrous model)
- Chip drawer
- Emergency stop button
- Clear awareness barrier with safety interlock switch
- Mist coolant lubrication system
- Material feed direction can be either:  
R → L or L → R (must specify)
- Miter in only one direction (manually)
- Semi-auto operation is standard for cutting miters
- Automatic loading & trim cut of each new bar
- Piece counter
- Touch screen controls
- Windows® based software (Includes profile screen)
- Unlimited job storage
- One saw blade
- One gallon coolant
- Complies with ANSI B 11.10 safety standards
- Two-year warranty on parts (Saw)
- One-year warranty on parts (Feed system)
- Made in USA

## OPTIONAL EQUIPMENT

- Bundle loader magazine (see page 35)
- Flood coolant

## MAXIMUM CAPACITIES

(with a 350 mm blade)

| Tubing            | 90 Degree        | 45 Degree        |
|-------------------|------------------|------------------|
| Round             | 3" (76 mm)       | 2" (51 mm)       |
| Square            | 3" (76 mm)       | 2" (51 mm)       |
| <b>Solid</b>      | <b>90 Degree</b> | <b>45 Degree</b> |
| Round             | 1-3/4" (45 mm)   | 1-1/2" (38 mm)   |
| <b>Solid (NF)</b> | <b>90 Degree</b> | <b>45 Degree</b> |
| Round             | 3" (76 mm)       | 2" (51 mm)       |
| Square            | 3" (76 mm)       | 2" (51 mm)       |



AutoLoader  
Supply Table

## SPECIFICATIONS

|                                     |                                   |                          |
|-------------------------------------|-----------------------------------|--------------------------|
| <b>Length Tolerance</b>             | ±0.015" repeatability             |                          |
| <b>Squareness Tolerance</b>         | ±0.002" per diameter inch         |                          |
| <b>Minimum Cut Length</b>           | 1/2" (12 mm)                      |                          |
| <b>Maximum Cut Length</b>           | 23' 9" (724 cm)                   |                          |
| <b>Motor Options (must specify)</b> | 208/230/460v, 3ph                 |                          |
| <b>Air Pressure</b>                 | 90 psi                            |                          |
| <b>Maximum Diameter Blade</b>       | 350 mm                            |                          |
| <b>Arbor Bore Size</b>              | 40 mm                             |                          |
| <b>Pin Spacing</b>                  | 4/12/64                           |                          |
| <b>12' Supply Table (ST)</b>        | <b>Maximum Raw Stock (12' ST)</b> | 12'                      |
|                                     | <b>Load Table Capacity</b>        | 24"                      |
|                                     | <b>Dimensions - 12' ST w/Saw</b>  | (L) 236" (W) 47" (H) 68" |
| <b>24' Supply Table (ST)</b>        | <b>Maximum Raw Stock (24' ST)</b> | 24'                      |
|                                     | <b>Load Table Capacity</b>        | 24"                      |
|                                     | <b>Dimensions - 24' ST w/Saw</b>  | (L) 377" (W) 47" (H) 68" |

## CUTTING SPEEDS

|                                 |  |
|---------------------------------|--|
| <b>CPO 350 (Ferrous)</b>        | Variable Speed 11 to 177 rpm<br>5 hp (3.73 kW) |
| <b>CPO 350 NF (Non-Ferrous)</b> | 3,000 rpm<br>5 hp (3.73 kW)                    |



COLD SAWS

# Upcut Miter *SUP Series*

Large capacity precision mitering upcut saw for aluminum, non-ferrous metals, and plastic cutting. Available in 20" or 24" blade models.

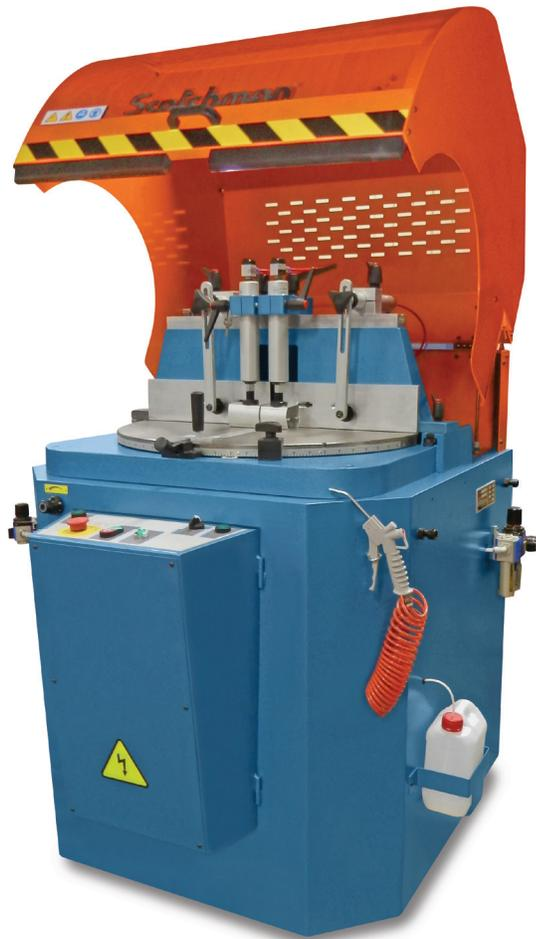

COLD SAWS

## STANDARD FEATURES

- Non-Ferrous saw
- Miter capabilities with fixed stops at 22.5°, 45°, 90°, 135°, and 157.5°
- Safety hood with safety interlock switch
- Power hood (SUP-600 NF model)
- Blade door with safety interlock switch
- Dual palm buttons
- Adjustable feed rate on saw head
- Two horizontal pneumatic clamps
- Two vertical pneumatic clamps
- Capable of slotting
- Moveable back fence for larger capacity
- One gallon coolant
- Mist lubrication system
- One carbide tipped blade
- Air hose
- Chip collection drawer in base and 4-3/4" chip collection port
- Adjustable leveling pads
- Meets CE standards
- Three-year warranty on parts
- Made in Spain

## CUTTING SPEEDS

|            |                              |
|------------|------------------------------|
| SUP-500 NF | 3,000 rpm<br>5.5 hp (4.1 kW) |
| SUP-600 NF | 3,000 rpm<br>5.5 hp (4.1 kW) |



▷ Manual to Full-Auto Feed Systems Available.  
(See pages 43-46)

## SUP-500 NF

### MAXIMUM CAPACITIES

(With a 500 mm Dia Blade)

|           | 90 Degree   | 45 Degree                      |
|-----------|---|--------------------------------|
| Round     | 7" (178 mm)   | 7" (178 mm)                    |
| Square    | 6" (152 mm)   | 4-3/4" (121 mm)                |
| Rectangle | 7-3/4" x 5" (197 x 127 mm) *FS<br>12" x 4" (305 x 102 mm) *FB | 5-3/4" x 4-3/4" (146 x 121 mm) |

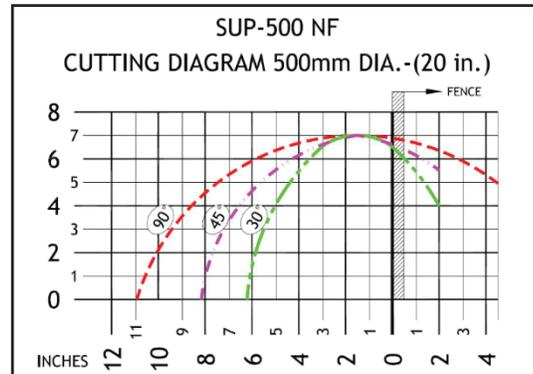

## SUP-600 NF

### MAXIMUM CAPACITIES

(With a 600 mm Dia Blade)

|           | 90 Degree   | 45 Degree               |
|-----------|---|-------------------------|
| Round     | 9" (229 mm)   | 9" (229 mm)             |
| Square    | 8" (203 mm)   | 7" (178 mm)             |
| Rectangle | 8-1/2" x 6" (216 x 152 mm) *FS<br>15" x 6" (381 x 152 mm) *FB | 10" x 4" (254 x 102 mm) |

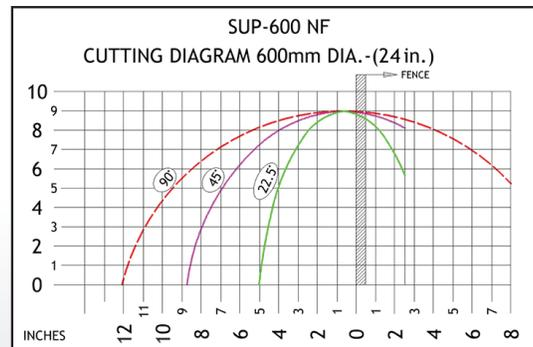

## SPECIFICATIONS

|                              | SUP-500             | SUP-600             |
|------------------------------|---------------------|---------------------|
| Motor Options (must specify) | 230/460v, 3ph       |                     |
| Air Pressure                 | 90 psi              |                     |
| Maximum Diameter Blade       | 500 mm              | 600 mm              |
| Arbor Bore                   | 50 mm               | 50 mm               |
| Width                        | 42" (107 cm)        | 49-1/4" (126 cm)    |
| Depth                        | 45-3/8" (115 cm)    | 54-1/2" (139 cm)    |
| Height (top of the hood)     | 60-1/4" (153 cm)    | 64-3/8" (164 cm)    |
| Height (floor to table)      | 38-5/8" (98 cm)     |                     |
| Shipping Weight (may vary)   | 1,200 lbs. (545 kg) | 1,465 lbs. (665 kg) |

\*FS = Fence Standard \*FB = Fence Back All specs are fence back, unless otherwise noted.

# AngleMaster Upcut Miter

## SUP-600 AngleMaster

### MAXIMUM CAPACITIES

(With a 600 mm Dia Blade)

|           | 90 Degree                 | 45 Degree                     |
|-----------|---------------------------|-------------------------------|
| Round     | 8" (203 mm)               | 7" (178 mm)                   |
| Square    | 7" (178 mm)               | 6" (152 mm)                   |
| Rectangle | 9" x 5"<br>(229 x 127 mm) | 7" x 4-3/4"<br>(178 x 121 mm) |

### ANGLE MASTER 600 CUTTING DIAGRAM 600mm (24") DIA.

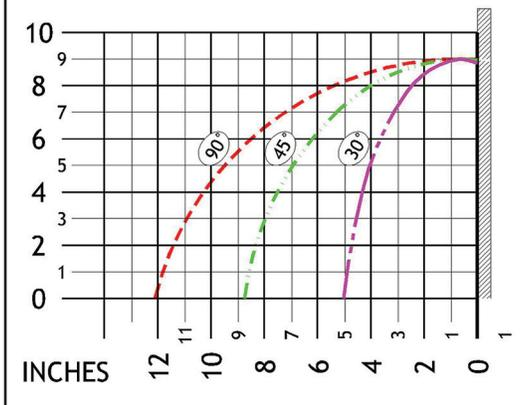

### SPECIFICATIONS

|                              | SUP-600          |
|------------------------------|------------------|
| Motor Options (must specify) | 230/460v, 3ph    |
| Air Pressure                 | 90 psi           |
| Maximum Diameter Blade       | 600 mm           |
| Arbor Bore                   | 50 mm            |
| Width                        | 49-1/4" (126 cm) |
| Depth                        | 54-1/2" (139 cm) |
| Height (top of the hood)     | 64-3/8" (164 cm) |
| Height (floor to table)      | 38-5/8" (98 cm)  |

### CUTTING SPEEDS

|            |                               |
|------------|-------------------------------|
| SUP-600 NF | 3,000 rpm<br>5.5 hp (3.73 kW) |
|------------|-------------------------------|

Large capacity upcut saw for aluminum, plastic, and non-ferrous metals. Combines an automatic mitering ability with a programmable feed.



This precision semi-automatic programmable sawing system automatically rotates to cut any angle, pushes material into the saw, then automatically rotates to the next desired angle.

### STANDARD FEATURES

- Non-ferrous saw
- Semi automatic operation
- Mitering degree range 22° to 159°
- Feeding length available - 10' to 30'
- Right-to-Left feed only
- Touch screen controls
- Windows® based software (includes profile screen)
- Unlimited job storage
- Powered safety hood with safety interlock switch
- Blade door with safety interlock switch
- Dual palm buttons
- Adjustable feed rate on saw head
- Two horizontal pneumatic clamps
- Two vertical pneumatic clamps
- Capable of slotting
- One gallon coolant
- Mist coolant lubrication system
- One carbide tipped blade
- Air hose
- Chip collection drawer in base and 4-3/4" chip collection port
- Adjustable leveling pads
- Meets CE standards
- Two-year warranty on parts (saw)
- One-year warranty on parts (feed system)
- Saw Made in Spain
- Feed system Made in USA

### Straight Cuts – Miter Cuts – and Everything In-Between



### OPTIONAL FEATURE

- **Auto 90° program** allows machine to run in full auto mode when cutting at 90°.

# Automatic Upcut

Large capacity automatic upcut saw for cutting non-ferrous materials at 90°. Fits almost any profile and is capable of drilling and tapping holes with DT20 option.

## GAA-500-90

### MAXIMUM CAPACITIES

(With a 500 mm Dia Blade)

|           | 90 Degree              |
|-----------|------------------------|
| Round     | 6" (152 mm)            |
| Square    | 6" x 6" (152 x 152 mm) |
| Rectangle | 10" x 3" (254 x 76 mm) |

### GAA-500-90

CUTTING CAPACITY- Ø500mm (20") BLADE

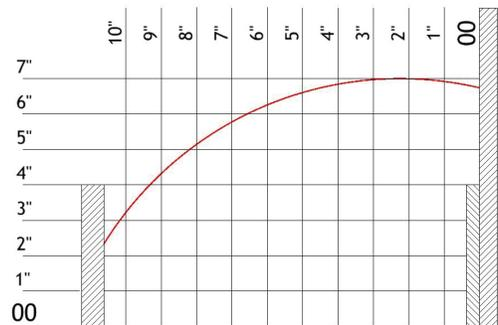

COLD SAWS



### STANDARD FEATURES

- Non-ferrous saw
- Shuttle feed design cuts at 90° only
- Automatic or Semi-automatic operation
- Automatic feeder, 20" x 2 strokes (20" + 20" Max. double advance)
- Adjustable length selector from 0.200 to 20"
- LED lighting
- Powered hood lift
- Emergency stop
- Adjustable cutting & feeding speeds
- Three horizontal pneumatic clamps
- Three vertical pneumatic clamps
- One gallon coolant
- Mist coolant lubrication system
- One carbide tipped blade
- Air hose
- Base designed as a chip collection with two extraction ports
- Adjustable leveling pads
- Meets CE standards
- Two-year warranty on parts
- Made in Spain

### SPECIFICATIONS

|                              | GAA-500-90          | GAA-500-90 DT20             |
|------------------------------|---------------------|-----------------------------|
| Length Tolerance             | ±0.006" per index   | ±0.006" per index           |
| Motor Options (must specify) | 230/460v, 3ph       |                             |
| Air Pressure                 | 90 psi              | 90 psi                      |
| Maximum Diameter Blade       | 500 mm              | 500 mm                      |
| Arbor Bore                   | 50 mm               | 50 mm                       |
| Width                        | 75" (191 cm)        | 75" (191 cm)                |
| Depth                        | 42" (107 cm)        | 52-1/2" (133 cm)            |
| Height (top of hood)         | 60-1/4" (153 cm)    | 81" (206 cm) (top of drill) |
| Height (floor to table)      | 38-5/8" (98 cm)     | 38-5/8" (98 cm)             |
| Shipping Weight (may vary)   | 1,300 lbs. (590 kg) | 1,535 lbs. (696 kg)         |

### CUTTING SPEEDS

|                 |                               |
|-----------------|-------------------------------|
| GAA-500-90      | 3,000 rpm<br>7.5 hp (5.59 kW) |
| GAA-500-90 DT20 | 3,000 rpm<br>7.5 hp (5.59 kW) |

### OPTIONAL EQUIPMENT

- Drill/Tap 20mm (DT20) (shown at left)
- CNC Controls can be added to DT20 models.



Optional Drill/Tap



# Automatic Upcut CNC

Precision CNC controlled upcut circular saw for cutting aluminum, plastic, or non-ferrous metals at 90°.



## GAA-600-90 CNC

### MAXIMUM CAPACITIES

(With a 600 mm Dia Blade)

|           | 90 Degree               |
|-----------|-------------------------|
| Round     | 8" (203 mm)             |
| Square    | 8" x 8" (203 x 203 mm)  |
| Rectangle | 14" x 4" (356 x 102 mm) |

### GAA-600 CNC

CUTTING CAPACITY Ø600mm (24") Blade

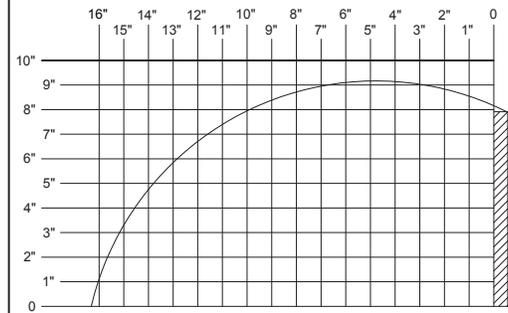

COLD SAWS

### STANDARD FEATURES

- Non-ferrous saw
- Shuttle feed design cuts at 90° only
- Automatic or semi-automatic operation
- Precision CNC controls
- 27" of ballscrew servomotor automatic feeder
- Unlimited stroke
- LED lighting
- Powered hood lift
- Emergency stop
- Adjustable cutting & feeding speeds
- Three horizontal pneumatic clamps
- Three vertical pneumatic clamps
- One gallon coolant
- Mist coolant lubrication system
- One carbide tipped blade
- Air hose
- Base designed as a chip collection with two extraction ports
- Adjustable leveling pads
- Meets CE standards
- Two-year warranty on parts
- Made in Spain

### SPECIFICATIONS

|                               | GAA-600 CNC        |
|-------------------------------|--------------------|
| Length Tolerance:             | ±0.006" per index  |
| Motor Options: (must specify) | 230/460v, 3ph      |
| Air Pressure:                 | 90 psi             |
| Maximum Diameter Blade:       | 600 mm             |
| Arbor Bore:                   | 50 mm              |
| Width:                        | 75" (191 cm)       |
| Depth:                        | 60" (152 cm)       |
| Height (top of hood):         | 65" (165 cm)       |
| Height (floor to table):      | 38-5/8" (98 cm)    |
| Shipping Weight: (may vary)   | 1750 lbs. (794 kg) |

### CUTTING SPEEDS

|             |                               |
|-------------|-------------------------------|
| GAA-600 CNC | 3,000 rpm<br>7.5 hp (5.59 kW) |
|-------------|-------------------------------|

# Saw Blades

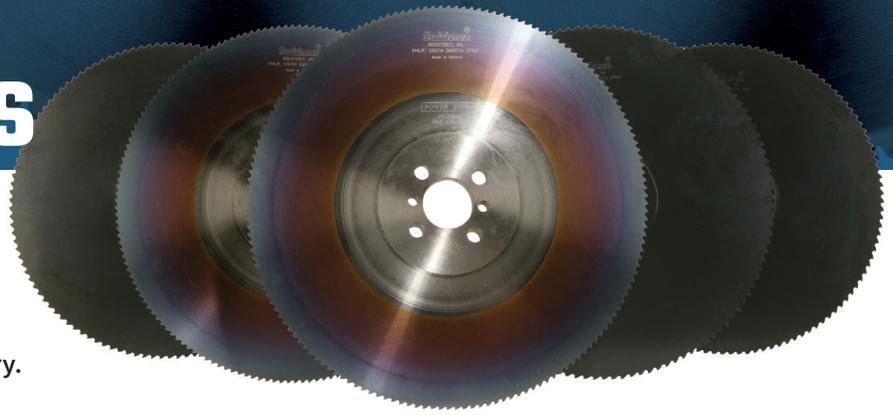

## IN STOCK BLADES

A complete selection of blades and coolant available for immediate delivery.

### Carbide-tipped for non-ferrous models

**250 mm HSS-DMo5  
32 mm BORE  
2/8/45 & 2/11/63 Pin Spacing**

| Part No. | Thickness | Teeth |
|----------|-----------|-------|
| 74300    | 0.080     | 90    |
| 74304    | 0.080     | 100   |
| 74302    | 0.080     | 120   |
| 74306    | 0.080     | 150   |
| 74305    | 0.080     | 180   |
| 74307    | 0.080     | 240   |

**275 mm HSS-DMo5  
32 mm BORE  
2/8/45 & 2/11/63 Pin Spacing**

| Part No. | Thickness | Teeth |
|----------|-----------|-------|
| 74360    | 0.080     | 90    |
| 74361    | 0.080     | 100   |
| 74362    | 0.080     | 120   |
| 74363    | 0.080     | 150   |
| 74365    | 0.080     | 180   |
| 74366    | 0.080     | 220   |
| 74367    | 0.080     | 260   |

**Non-Ferrous Standard Cold Saw Blades  
40 mm BORE  
2/8/55 & 4/12/64 Pin Spacing**

| Part No. | Thickness | Diameter | Teeth       |
|----------|-----------|----------|-------------|
| 74334    | 0.091     | 300 mm   | 120 Carbide |
| 74327    | 0.134     | 300 mm   | 72 Carbide  |
| 74329    | 0.134     | 350 mm   | 84 Carbide  |

**50 mm BORE 2/15/80 Pin Spacing**

| Part No. | Thickness | Diameter | Teeth       |
|----------|-----------|----------|-------------|
| 74490    | 0.161     | 500 mm   | 80 Carbide  |
| 74495    | 0.181     | 500 mm   | 96 Carbide  |
| 74500    | 0.181     | 500 mm   | 120 Carbide |
| 74505    | 0.177     | 600 mm   | 72 Carbide  |
| 74510    | 0.181     | 600 mm   | 132 Carbide |

COLD SAWS

**275 mm HSS-DMo5  
40 mm BORE  
2/8/55 & 4/12/64 Pin Spacing**

| Part No. | Thickness | Teeth |
|----------|-----------|-------|
| 74309    | 0.100     | 90    |
| 74308    | 0.100     | 100   |
| 74310    | 0.100     | 120   |
| 74311    | 0.100     | 150   |
| 74312    | 0.100     | 180   |
| 74313    | 0.100     | 220   |
| 74314    | 0.100     | 260   |

**315 mm HSS-DMo5  
40 mm BORE  
2/8/55 & 4/12/64 Pin Spacing**

| Part No. | Thickness | Teeth |
|----------|-----------|-------|
| 74355    | 0.100     | 90    |
| 74356    | 0.100     | 100   |
| 74357    | 0.100     | 110   |
| 74345    | 0.100     | 120   |
| 74348    | 0.100     | 150   |
| 74350    | 0.100     | 180   |
| 74352    | 0.100     | 220   |
| 74354    | 0.100     | 280   |

**350 mm HSS-DMo5  
40 mm BORE  
2/8/55 & 4/12/64 Pin Spacing**

| Part No. | Thickness | Teeth |
|----------|-----------|-------|
| 74390    | 0.100     | 90    |
| 74391    | 0.100     | 100   |
| 74392    | 0.100     | 110   |
| 74393    | 0.100     | 120   |
| 74394    | 0.100     | 150   |
| 74395    | 0.100     | 180   |
| 74396    | 0.100     | 220   |
| 74397    | 0.100     | 280   |

**POWER 2000 Blades  
315 mm • 40 mm BORE  
2/8/55 & 4/12/64 Pin Spacing**

| Part No. | Thickness | Teeth |
|----------|-----------|-------|
| 074372   | 0.070     | ALL   |

PVD coated for longer blade life with a notched grind for faster cutting speeds. Designed to operate at 80 to 170 RPM, Maximum wall thickness 0.100.

**PERFORMANCE 3000 Blades  
315 mm • 40 mm BORE  
2/8/55 & 4/12/64 Pin Spacing**

| Part No. | Thickness | Teeth |
|----------|-----------|-------|
| 074349   | 0.098     | ALL   |

PVD coated for longer blade life. Designed for solids and 0.100 wall tube or thicker.

## BAND SAW BLADES

- Made in USA

| Part No. | Size       | Teeth    |
|----------|------------|----------|
| 074600   | 1" x 96.5" | 4-6 TPI  |
| 074610   | 1" x 96.5" | 6-10 TPI |

## COOLANT

- Synthetic sawing coolant for mild and stainless steel
- Syncon2 lubricant for non-ferrous

# Saw Services & Equipment

## Blade Sharpening Service

Scotchman's in-house blade sharpening service is fast and provides high-quality and consistent results. Our specialist can sharpen any HSS blade, re-tooth a chipped blade, or do a complete gum & sharpen, and will grind your blade to any number of teeth you request.



## Test Cuts/Cycle Times

Scotchman offers Free test cutting of your material and can evaluate your application. Our specialists will provide a full analysis of cycle times, optional RPMs, and offer saw and saw blade recommendation and tooth configuration.

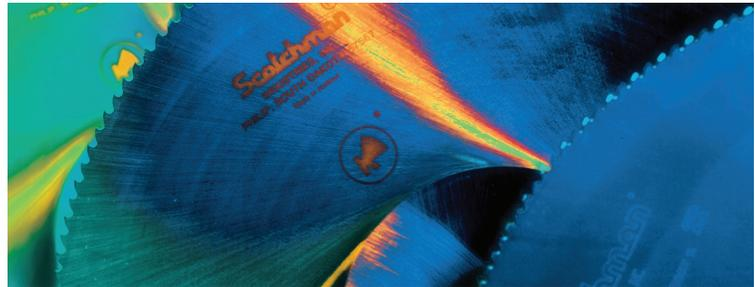

COLD SAWS

## Chip Vacuum

This high-efficiency industrial Vac is ideal for collecting aluminum, dust, chips, and plastic shavings.

### STANDARD FEATURES

- Centrifugal fan with a flow rate of 1471 CFM
- Container capacity 42-gallon
- Structure completely made of steel
- Anti-scuff wheels with parking brake
- Quick release collection container
- Visual filling indicator
- Pneumatic vibrating motor for filter cleaning
- 4.8 hp motor – 230/460v, 3ph, 60Hz
- Two 6" ports
- Five meters of 5" flex tube
- Made in Italy

### OPTIONAL FEATURES

- Remote start control
- Cleaning kit for post-work machine cleaning



## AccuTable Digital Caliper

Easily make critical quality control measurements with the AccuTable from Scotchman®. This high-precision caliper table accurately measures material up to 16-foot-long to  $\pm 0.004"$ . The Windows® Tablet PC effortlessly reads and stores measurements and can be accessed wirelessly over your network. Customized solutions can calculate SPC (Statistical Process Control) information, create graphs, charts, and more – plus, it is American Made.

### STANDARD FEATURES

- Accuracy  $\pm 0.004"$  over 10 ft.
- Repeatability  $\pm 0.0015"$
- Windows® tablet PC
- Built-in WiFi and USB port
- Inch / metric conversions
- Available in 8, 10, 12, 14, and 16 ft. lengths
- 1-year factory warranty
- 5-year belt warranty
- Made in USA



# Measuring *Manual*

- Enhance Accuracy • Boost Productivity
- Maximize Cutting Efficiency • Improve Safety
- Decrease Set-Up Time • Eliminate Waste

We specialize in high-precision length measuring gauges and turnkey automation solutions for the steel and aluminum industries. Take your operations to a whole new level by adding an automated measuring system to your current machine.

Manual to fully automatic systems available. Talk to our specialists to find the best solution for your needs.



## Scotchman Measuring Devices

|  |    |
|--|----|
| Manual Length Positioner .....             | 43 |
| Digital Length Gauge & Positioner .....    | 44 |
| Semi-Automatic Stop/Pusher System .....    | 45 |
| Fully Automatic Material Feed System ..... | 46 |
| Quality Control Caliper Table .....        | 42 |

## Manual Length Positioners

Replace your tape measure with one of our Patented Loc-Stop Systems to increase accuracy and reduce set-up times. The teeth on the rail (1/16" increments) align together with the teeth on the stainless-steel stops to give you the exact measurement you set and are guaranteed not to slip.

Available in left-hand and right-hand models and adaptable to almost ANY type of machinery.

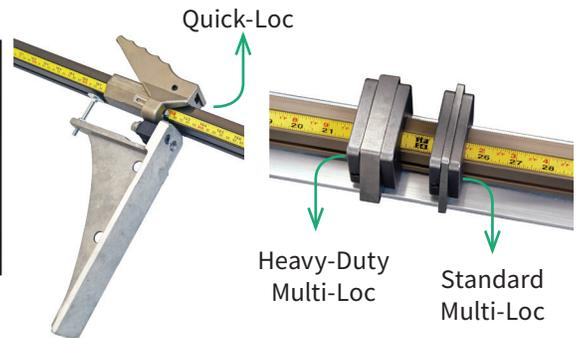

## Quick-Loc Stop System (AMS)

Simply squeeze the handle on the Quick-Loc System, slide it into position, and release it. Your measurement is set and will not slip.



**10" Extension**  
Available for Quick-Loc.

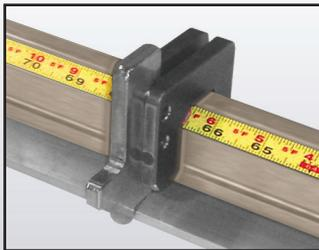

**Vertical Stop Block**  
Available for Multi-Loc.

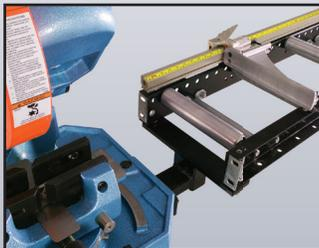

**Roller Conveyor**  
Available for Quick-Loc & Multi-Loc.  
5' & 10' Increments;  
up to 25 foot lengths.

## Multi-Loc Stop System (AMS)

This system makes setting your production runs faster. Simply press down the stainless-steel stops at various lengths along the rail so you're not changing the set-up each time. Multiple stops can be placed on the rail as close to 1" apart using the Standard Stops, and 1-1/2" apart using the Heavy Duty stops.

Three stops come standard with each Multi-Loc Stop System.

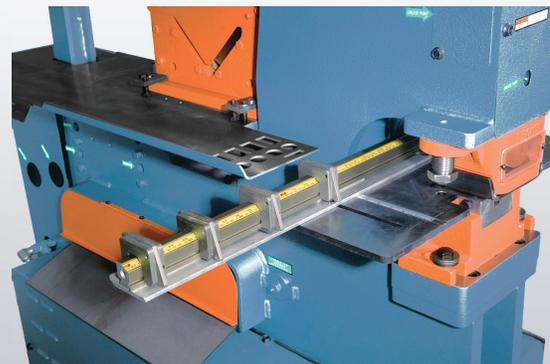

**Multi-Loc Stop System shown on a Scotchman Ironworker.**

MEASURING DEVICES

OPTIONAL

# Measuring *Digital*

## Digital Length Gauge LG Measuring Device

**Slide & Measure – It's that simple!**

Add digital measuring capability to the angle shear or bar shear on your ironworker so you can measure faster & more precisely without the need for a tape measure and pencil. Just clamp this LG Device to your work station bracket and it displays a digital measurement of any material slid underneath it.

Our LG Measuring Kit comes with one Digital Length Gauge and both an Angle Shear mount & a Bar Shear mount.



On Bar Shear



On Angle Shear

### FEATURES

- Blade Kerf & Angle Compensation
- Quick attach/detach to move from one station to the next

### TECHNICAL SPECS

- Accuracy –  $\pm 0.029''$
- Precision –  $\pm 0.019''$
- Warranty – 1 Year Limited
- Power – 2 AA Batteries (not included)

### DISPLAY UNITS

- Decimal Inch
- Fractional Inch (1/16")
- Fractional Inch (1/32")
- Foot to Inch (Decimal)
- Foot to Inch (Fractional)
- Millimeters
- Centimeters
- Meters



Scan QR code to watch this device in action!



MEASURING DEVICES

## Digital Length Positioner Digital Quick Stop

**Simple Go-To Stop**

Turn your manual saw into a part cutting workhorse using this entry level digital length gauge that is easy to use and calibrate. The Digital Quick Stop is guaranteed to save time, reduce scrap, and eliminate costly mistakes. Simply key in the desired cut length and press go; the positioner then moves to that desired length. Place your material up against the fence and make your cut.

### FEATURES

- Positioner accuracy  $\pm 0.008''$
- FAST! 17 inches/second
- 7" Android tablet
- Works in inches, fractions, decimals, or metric
- Fraction keys work as the "go" key
- Unlimited preset keys & list storage
- Mounts left  $\rightarrow$  right OR right  $\rightarrow$  left (must specify)
- Available in 8' & 12' lengths
- One-year factory warranty
- Made in USA



| Current Position |   | Target Position |        | Inches |       | Millimeters |        | Main Screen | Cutlist Screen | Preset Stops | Setup Screen |
|------------------|---|-----------------|--------|--------|-------|-------------|--------|-------------|----------------|--------------|--------------|
| 7                | 8 | 9               | 25.000 | 1/16   | 1/8   | 3/16        | 1/4    | GO          |                |              |              |
| 4                | 5 | 6               |        | 0.0625 | 0.125 | 0.1875      | 0.25   |             |                |              |              |
|                  |   |                 |        | 5/16   | 3/8   | 7/16        | 1/2    |             |                |              |              |
|                  |   |                 |        | 0.3125 | 0.375 | 0.4375      | 0.5    |             |                |              |              |
| 1                | 2 | 3               |        | 9/16   | 5/8   | 11/16       | 3/4    |             |                |              |              |
|                  |   |                 |        | 0.5625 | 0.625 | 0.6875      | 0.75   |             |                |              |              |
| .                | 0 | C               |        | 13/16  | 7/8   | 15/16       | UNLOAD |             |                |              |              |
|                  |   |                 |        | 0.8125 | 0.875 | 0.9375      |        |             |                |              |              |



Scan QR code to watch this system in action!

# Measuring *Semi-Auto*

## SEMI-AUTOMATED

# Stop/Pusher System

### Programmable length stop or material pusher

This programmable measuring system eliminates operator error and is easily programmed to measure length or has the ability to push material to a desired length. Simply enter a part length and the stop will advance to that position quickly and accurately. This Stop/Pusher System can move one length at a time or be programmed with a series of lengths and quantities for faster operation.

#### FEATURES

- Positioner accuracy  $\pm 0.008$ "
- 17" Screen – Windows® touchscreen technology
- Works in inches, fractions, decimals, or metric
- Fraction keys work as the "go" key
- Unlimited preset keys & list storage
- Supports barcodes
- Multi offset allows for multiple tool positions
- Electronic zero-point calibration
- Multi-lingual
- Steel reinforced belt drive with adjustable drive speed of 1" to 25"/second
- Mounts left → right OR right → left (*must specify*)
- Available in 8' to 30' lengths
- One-year factory warranty
- Made in USA

#### STOP/PUSHER FUNCTIONS

- Auto Pusher Mode
- Batch Mode
- Incremental Mode
- Set Point Mode



System is able to be paired with various types of equipment (Shown on our DO95 Ironworker)

# Measuring *Full-Auto*

## FULLY-AUTOMATED Auto Feed System (AFS)

### Fully automatic material feed system

Turn your semi-automatic saw into a fully-automatic production machine. The Advanced Feed System (AFS) will cut production time in half, virtually eliminating set-up time! Now, operators no longer need to use a tape measure or set and adjust manual stops. Pairs with Scotchman's CPO 350 PKPD & SUP series saws.



AUTOMATION

### FEATURES

- System accuracy  $\pm 0.015"$
- 17" Screen – Windows® touchscreen technology
- Intuitive interface
- Works in inches, fractions, decimals, or metric
- Fraction keys work as the “go” key
- Unlimited storage space to save cut jobs
- Able to switch between stop mode & pusher mode
- Capable of miter cutting in semi-auto mode
- Supports barcodes
- Multi offset allows for multiple tool positions
- Downloading of cut lists via built-in wireless networking or through USB drive
- Multi-lingual
- Carriage rides on linear bearing system
- Planetary gear head, near zero backlash
- Mounts left → right OR right → left (*must specify*)
- Available in 8' to 30' lengths
- One-year factory warranty
- Made in USA

### AUTOMATIC SEQUENCES

- Push stock to cut length
- Consider blade kerf
- Clamp the material
- Trigger the cut cycle
- Release the clamp
- Index to the next cut position & repeat!

### AUTO FEED FUNCTIONS

- Auto Pusher Mode
- Batch Mode
- Incremental Mode
- Set Point Mode
- Auto List (Optimizing)



Scan QR code to watch  
this system in action!

# Pipe Notchers

## Create the Perfect Notch in Seconds!

This line of notching equipment is top-quality, perfect for double corner joints, great for high production, and *always* backed by Scotchman's superior three-year warranty.

Ideal for steel, stainless steel, and non-ferrous tube & pipe construction, hand rails, gates & fences, car frames, roll cages, and more. Each piece is quickly and accurately notched and produces a gap-free fit ready for welding.

The manual and electric notchers are perfect for quick-fit 90° notches. Abrasive grinder/notchers provide the perfect saddle for unique angles on both round and square applications.

## Manual Pipe Notchers



**AL1**

3/4", 1", & 1-1/4"

**AL2**

1-1/2" & 2"

**AL3**

1-1/4" & 1-1/2"

**ALU**

Vent notch; 0.155" max. wall thickness

### FEATURES

- Portable and easy to mount to any stationary surface
- Notch several diameters up to schedule 40 wall thickness at 90°
- Requires no change-over or costly attachments
- Made in the Netherlands



## Electric Pipe Notchers

**AL1-2E**



**AL1-2U**



### FEATURES

- Equipped to notch 3/4", 1", 1-1/4", 1-1/2" and 2" up to schedule 40 wall thickness at 90°
- Safety guards surround and protect notching dies
- Made in the Netherlands

### SPECIFICATIONS

|                                     |  |
|-------------------------------------|--|
| <b>Motor Options (must specify)</b> | 3.5hp<br>230/460v, 3ph                                 |
| <b>Dimensions</b>                   | 30" x 13-1/2" x 11-1/2"<br>(762mm x 343mm x 292mm)     |
| <b>Shipping Weight (may vary)</b>   | AL1-2E: 230 lbs. (104 kg)<br>AL1-2U: 230 lbs. (104 kg) |



Equipped with a vent notching die to quickly create a uniform vent-notch in round or square workpieces for galvanizing outflow

PIPE NOTCHERS

# Pipe Notchers

## Abrasive Grinder/Notchers

Constructed with heavy-duty base and frame, Scotchman's Grinder/Notchers operate smoothly with minimal vibrations. Each machine is designed for easy setup with one vise to hold all sizes of tube & pipe that is graduated in degrees and a mandrel with centerline adjustments. Tool-free belt and mandrel changes make transitions quick and easy.

### AL100 SERIES FEATURES

- Notches via adjustments straight = 90° to 30° in tube or pipe from 1/2" I.D. to 3" O.D. in seconds (chart pg. 50)
- Comes with two belts and two pipe mandrels (1-1/4" & 1-1/2")
- 13 optional mandrels available to ensure gap free fit
- Top mounted deburring table
- Two axis precision crossfeed table with hand lever feed handle (AL100U-01) or handwheels (AL100U-02)
- Made in the Netherlands



AL100U-01



AL100U-02



### SPECIFICATIONS

|                                     | AL100U-01   | AL100U-02   | AL150   | AL150-HS  |
|-------------------------------------|---|---|---|---|
| <b>Belt</b>                         | 4" x 78-3/4"<br>(100mm x 2,000mm)                         | 4" x 78-3/4"<br>(100mm x 2,000mm)                         | 6" x 78-3/4"<br>(150mm x 2,000mm)                         | 6" x 78-3/4"<br>(150mm x 2,000mm)                         |
| <b>Speed</b>                        | 4.5 hp, 3,420 RPM   | 4.5 hp, 3,420 RPM   | 6 hp, 3,420 RPM   | 6 hp, 4,320 RPM   |
| <b>Grinding Capacity</b>            | 1/2" I.D. to 3" O.D.                                      | 1/2" I.D. to 3" O.D.                                      | 1/2" I.D. to 4-1/2" O.D.                                  | 1/2" I.D. to 4-1/2" O.D.                                  |
| <b>Angle Range</b>                  | Straight= 90° to 30°                                      | Straight= 90° to 30°                                      | Straight= 90° to 20°                                      | Straight= 90° to 20°                                      |
| <b>Motor Options (must specify)</b> | 230/460v, 3ph<br>220v, 1ph                                | 230/460v, 3ph<br>220v, 1ph                                | 230/460v, 3ph<br>220v, 1ph                                | 230/460v, 3ph<br>*HS only comes in 3ph                    |
| <b>Dimensions</b>                   | L- 57" (145cm)<br>W- 45-1/4" (115cm)<br>H- 25-1/2" (65cm) | L- 57" (145cm)<br>W- 45-1/4" (115cm)<br>H- 25-1/2" (65cm) | L- 57" (145cm)<br>W- 47-1/4" (120cm)<br>H- 33-1/2" (85cm) | L- 57" (145cm)<br>W- 47-1/4" (120cm)<br>H- 33-1/2" (85cm) |
| <b>Shipping Weight (may vary)</b>   | 460 lbs. (209 kg)   | 460 lbs. (209 kg)   | 615 lbs. (279 kg)   | 695 lbs. (315 kg)   |

PIPE NOTCHERS

### AL150 SERIES FEATURES

- Notches via adjustments straight = 90° to 20° in tube or pipe from 1/2" I.D. to 4-1/2" O.D. in seconds (chart on page 50)
- Two axis precision crossfeed table with both handwheels and hand lever feed handles.
- Comes with two belts and two pipe mandrels (1-1/4" & 1-1/2")
- 17 optional mandrels available to ensure a gap free fit
- Top mounted deburring table (AL150)
- BackHigh speed parts grinder (AL150-HS)
- Base has two built-in racks to store mandrels (AL150-HS)
- Made in the Netherlands



AL150

### High Speed Parts Grinder



AL150-HS

- Ideal for stainless & aluminum
- 40% faster than the AL150
- Less heat, minimal discoloration

# Pipe Notcher *Accessories*

## BACK GAUGE ACCESSORY

For All AL100 and AL150 Models

- Use to set length positions and control depth of notch for repeatable and accurate part lengths.
- 4 ft. working length

Scan to watch  
Back Gauge  
in Action

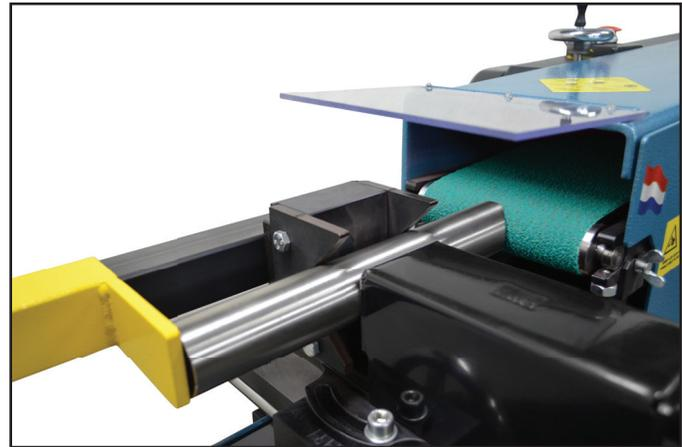

## Mandrels For Abrasive Grinder/Notchers

17 mandrel sizes available to ensure a gap-free fit.



PIPE NOTCHERS

### MANDREL SPECIFICATIONS

| Pipe   | Tube  | Decimal Size | AL100U-01 / AL100U-02<br>4" Part # | AL150 / AL150-HS<br>6" Part # |
|--------|-------|--------------|------------------------------------|-------------------------------|
| 1/2"   |       | 0.840        | A042.21.3                          | A043.21.3                     |
|        | 1.000 | 1.000        | A042.26                            | A043.26                       |
| 3/4"   |       | 1.060        | A042.26.9                          | A043.26.9                     |
|        | 1.250 | 1.250        | A042.32                            | A043.32                       |
| 1"     |       | 1.330        | A042.33.7                          | A043.33.7                     |
|        | 1.500 | 1.500        | A042.38                            | A043.38                       |
| 1-1/4" |       | 1.660        | A042.42.4                          | A043.42.4                     |
|        | 1.750 | 1.750        | A042.44                            | A043.44                       |
| 1-1/2" |       | 1.900        | A042.48.3                          | A043.48.3                     |
|        | 2.000 | 2.000        | A042.50                            | A043.50                       |
| 2"     |       | 2.375        | A042.60.3                          | A043.60.3                     |
|        | 2.500 | 2.500        | A042.63.5                          | A043.63.5                     |
| 2-1/2" |       | 2.875        | A042.73.1                          | A043.73.1                     |
|        | 3.000 | 3.000        | A042.76.1                          | A043.76.1                     |
| 3"     |       | 3.500        |                                    | A043.88.9                     |
|        | 3.500 | 3.500        |                                    | A043.88.9                     |
| 3-1/2" |       | 4.000        |                                    | A043.101.6                    |
| 4"     |       | 4.500        |                                    | A043.114.3                    |

# Pipe Notcher *Accessories*

## Belts For Abrasive Grinder/Notchers

### Productivity

In most applications, abrasive belt notchers dramatically increase productivity. Unlike conventional grinding wheels, abrasive belts are self-sharpening, continuously exposing fresh cutting points. This means no more dressing or replacing expensive grinding wheels.



$$\text{Productivity} = \frac{\text{belt cost} + \text{labor} + \text{overhead}}{\text{number of parts ground}}$$

### Metal Removal

The rate of metal removal is determined by material to be ground, belt type, belt speed (SFPM) and the amount of pressure applied during grinding.

| ABRASIVE GRINDING BELT SPECIFICATIONS      |             |                  |   |
|--|-------------|------------------|---|
| Length/Grit                                | Product No. | Packaging        | Description                               |
| 4" x 78-3/4" (100mm x 2,000mm) / 36 GRIT   | A044.00001  | 10 Belts Per Box | Rigid Belt for 3/4" & Larger Diameter     |
| 4" x 77-1/2" (100mm x 1,968.5mm) / 36 GRIT | A044.00003  | 10 Belts Per Box | Flexible Belt for 3/4" & Smaller Diameter |
| 6" x 78-3/4" (150mm x 2,000mm) / 36 GRIT   | A044.00002  | 10 Belts Per Box | Rigid Belt for 3/4" & Larger Diameter     |
| 6" x 77-1/2" (150mm x 1,968.5mm) / 36 GRIT | A044.00004  | 10 Belts Per Box | Flexible Belt for 3/4" & Smaller Diameter |

\*Notchers with serial numbers 0001000-0001300, 9701301-9701650 & 9801651-9801700 require 4" x 77" belts

### TECHNICAL DATA - 4" BELT

Maximum Notch Per Angle  
AL 100 (4" Wide Belt)

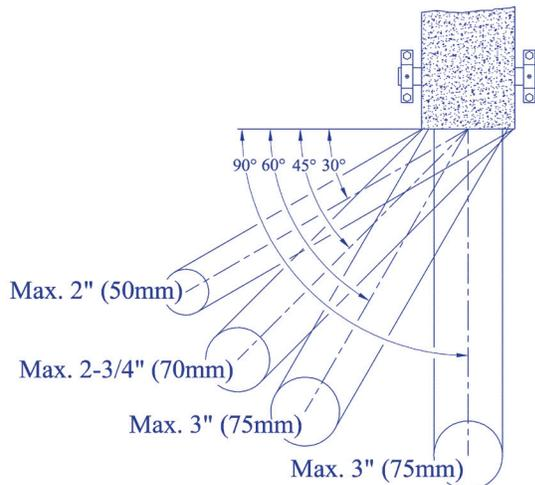

### TECHNICAL DATA - 6" BELT

Maximum Notch Per Angle  
AL 150 Series (6" Wide Belt)

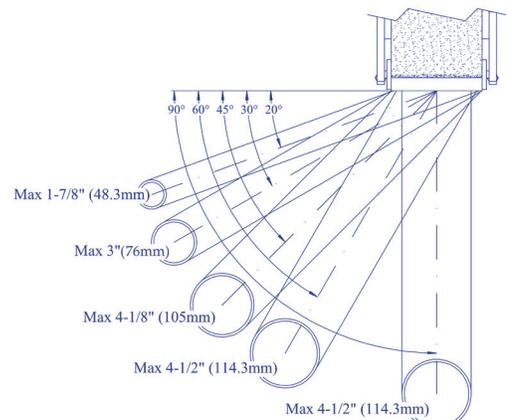

# Hydraulic Presses *PressPro Series*



**PressPro 66**  
66 ton



**PressPro 110**  
110 ton



**PressPro 110W**  
110 ton wide frame

## STANDARD FEATURES

- Heavy duty all-steel construction
- Industrial grade hydraulic system
- Ram moves laterally for added versatility
- 3 Ram speeds
- 15" of vertical ram travel
- Joystick operation with manual jog
- Removable ram cap to accept a wide variety of tooling
- Adjustable H-frame bed/table height offers increased versatility
- Open side-frame design allows for material to pass through
- Set of V-Blocks to simplify your pressing jobs (except model 176MT)
- Pressure gauge to monitor force
- Hydraulic-assist adjustable work table to maximize operator safety
- Built-in forklift accommodations (except model 176MT)
- Meets CE standards
- Three-year warranty
- Made in USA

## STEEL V-BLOCK SET

### Standard Accessory on All Models

(except model 176MT)



## OPTIONAL MANDREL SET

Available on PressPro 66, 110, 110W models



# Hydraulic Presses *PressPro Series*



**PressPro 176**  
176 ton



**PressPro 176MT**  
176 ton with movable frame

- The movable frame feature allows for overhead loading of heavy workpieces
- Easily slide the ram head (side to side) and press frame (forward and back) to access all different points of the work surface.

## SPECIFICATIONS

|                              | PressPro 66                            | PressPro 110                         | PressPro 110W (Wide Frame)         | PressPro 176                               | PressPro 176MT (Movable Frame)   |
|------------------------------|--|--------------------------------------|------------------------------------|--|--|
| Press Force                  | 66 tons (60 mt)                        | 110 tons (100 mt)                    | 110 tons (100 mt)                  | 176 tons (160 mt)                          | 176 tons (160 mt)  |
| Motor Rate                   | 2.5 hp (1.8 kW)                        | 3.5 hp (2.6 kW)                      | 3.5 hp (2.6 kW)                    | 5 hp (3.6 kW)                              | 5 hp (3.6 kW)  |
| Motor Options (must specify) | 230/460v, 3ph                          | 230/460v, 3ph                        | 230/460v, 3ph                      | 230/460v, 3ph                              | 230/460v, 3ph  |
| Ram Speed - Approach         | 21 ipm (8.69 mm/s)                     | 18 ipm (7.54 mm/s)                   | 18 ipm (7.54 mm/s)                 | 18 ipm (7.48 mm/s)                         | 18 ipm (7.48 mm/s)   |
| Ram Speed - Press            | 5 ipm (2.07 mm/s)                      | 6 ipm (2.47 mm/s)                    | 6 ipm (2.47 mm/s)                  | 6 ipm (2.40 mm/s)                          | 6 ipm (2.40 mm/s)  |
| Ram Speed - Return           | 25 ipm (10.79 mm/s)                    | 21 ipm (9.06 mm/s)                   | 21 ipm (9.06 mm/s)                 | 22 ipm (9.35 mm/s)                         | 22 ipm (9.35 mm/s)   |
| Open Height - Min.           | 6-5/16" (160 mm)                       | 8-1/4" (210 mm)                      | 8-1/4" (210 mm)                    | 9-1/2" (241 mm)                            | -  |
| Open Height - Max.           | 31-15/16" (811 mm)                     | 29-3/4" (755 mm)                     | 29-3/4" (755 mm)                   | 32" (813 mm)                               | 27-5/8" (702 mm) w/small ram cap   |
| Stroke                       | 15"                                    | 15"                                  | 15"                                | 15-3/4"                                    | 15-3/4"  |
| Lateral Ram Slide            | Yes                                    | Yes                                  | Yes                                | Yes  | Yes  |
| Width Between Uprights       | 29-1/2"                                | 43-1/4"                              | 59"                                | 43-3/16"                                   | 43-3/16"   |
| Width Between Table Channels | 11-15/16"                              | 14-1/4"                              | 14-1/4"                            | 17-1/16"                                   | 9-5/8"   |
| Table Height**               | Adjustable                             | Adjustable                           | Adjustable                         | Adjustable                                 | Fixed at 30"<br>Table Size (L x W):<br>54-1/2" x 38-1/2"<br>Frame Movement:<br>38-1/2"<br>Max Load:<br>1,653 lbs. (750 kg) |
| Footprint (L x W)            | 57-3/4" x 39-1/4"<br>(147 cm x 100 cm) | 67-1/2" x 41"<br>(171.5 cm x 104 cm) | 83-1/8" x 41"<br>(211 cm x 104 cm) | 69-1/8" x 42-3/8"<br>(175.5 cm x 107.5 cm) | 68-1/2" x 69"<br>(174 cm x 175.5 cm)   |
| Height Overall               | 82-3/4" (210 cm)                       | 83-3/8" (212 cm)                     | 83-3/8" (212 cm)                   | 87" (221 cm)                               | 85" (216 cm)   |
| Shipping Weight              | 1,600 lbs. (726 kg)                    | 3,000 lbs. (1,361 kg)                | 3,450 lbs. (1,565 kg)              | 3,680 lbs. (1,669 kg)                      | 4,500 lbs. (2,041 kg)  |

\*\*Movement of ram cylinder and press frame are done manually. Hydraulic assist for table height adjustment.

# Customer Service

At Scotchman, we stand behind our products with more than just an industry-leading warranty; we provide lifetime customer support and are committed to the success of our customers.

## Live, ON-SITE Demonstrations



### Convenient & Free.

See our machinery in action and test cut your material without leaving your place of business, anywhere in the lower 48 states.



**SCHEDULE YOUR  
ON-SITE DEMO**

Scan QR code or  
call (605) 859-2542



# SCOTCHMAN Lease-Purchase Financing



## Invest in Yourself

Get the equipment you need  
to grow your business today.

Scotchman Credit Corp. (SCC) offers  
Low Payments with Highly Competitive Rates!

### STRAIGHTFORWARD LEASING RATES AND TERMS

---

- Flexible 1-to-5 year terms with low rates based on purchase price -- *Monthly plans for businesses & yearly plans for schools*
- No hidden fees or early payoff penalty
- One-time \$100 documentation fee
- One advanced payment required for each year of the lease
- All contracts are Lease-To-Own: \$1.00 end-of-lease buyout

### MINIMUM QUALIFICATION REQUIREMENTS

---

- 2 years in business
- \$4,000 lease minimum
- Leasing not available in Alabama, New Jersey, Nevada, West Virginia, or countries outside of the United States.

### SIMPLE ONE-PAGE APPLICATION

Scan this code



FINANCING

### Contact Us

(605) 859-2542

[sccleasing@scotchman.com](mailto:sccleasing@scotchman.com)

MACHINES  
THAT WORK  
AS HARD  
AS YOU DO.

**Scotchman<sup>®</sup>**

Metal Fabricating Solutions

Scotchman Industries, Inc. 180 E US Hwy. 14 • PO Box 850 • Philip, SD 57567 USA  
Phone: (605) 859-2542 • Fax: (605) 859-2499 • info@scotchman.com • www.scotchman.com

