

# Scotchman<sup>®</sup>

## Metal Fabricating Solutions

### Cold Saw Blade Basics

01/2018



Scotchman Industries Inc. 180 E US Hwy 14- Philip, SD 57567 USA  
Phone 605.859.2542 - Fax 605.859.2499 - [www.scotchman.com](http://www.scotchman.com) - [info@scotchman.com](mailto:info@scotchman.com)

# THE COLD SAW BLADE

## MATERIAL

Most Cold Saw Blades are made out of M2 HSS (High Speed Steel) due to its abrasion resistance and its hardness, which is around 60 Rockwell. Drill bits are also made of this type of steel. Other types of steel can be used, such as M35 Cobalt, but are much less common and more expensive. Scotchman blades are made of HSS.

## BLADE SHARPENING

Cold Saw Blades can be re-sharpened! The diameter of the blade is reduced with every sharpening, as a small amount of material is ground from the rim each time. Scotchman uses new CNC sharpening equipment. Blades can be re-sharpened several times (30-40 under optimal conditions) or until they are too small to use.



## RUN-OUT

Typically, the maximum run-out tolerance for a cold saw blade is 0.01% of the blades diameter.

In other words - .001" per diameter inch. Cold Saw Blades are "Hollow Ground" which simply means they are thicker on the rim and gradually taper to a thinner thickness at the center "hub" of the blade. This allows the blade to pass through the material easier and it also helps to allow coolant into the cut.

## COATING

Cold Saw Blades have a coating. The most common is a "Steam Oxide" or "Black Oxide" coating. The coating helps the blade to hold its edge and helps to prevent galling as the blade passes through the cut. If you look at the Oxide coating under a microscope, it has tiny dips and craters that help to carry the coolant into the cut.

## OTHER COATINGS

Cold saw blades can also have more exotic coatings, such as a TIN (Titanium Nitride) coating. This increases wear resistance and works well with fine tooth blades. Our, Scotchman POWER 2000 and PERFORMANCE 3000 Blades, have this type of coating to increase blade life.

# TOOTH GEOMETRY, PITCH, & BEVEL

The following 3 pages show each of the above attributes. The graphics thoroughly explain each and will help to show what the proper blade is for the size & type of material to be cut. Once the proper pitch is decided then the number of teeth for the blade can be determined.

## COLD SAW BLADE TOOTH GEOMETRY

Tolerance is  $\pm 2^\circ$

### Proper Tooth Shape

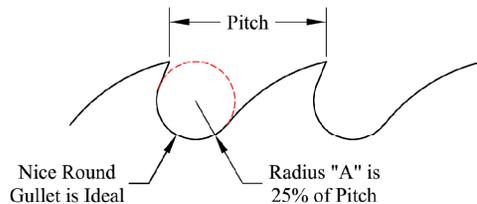

### Mild Steel some Low-Alloys

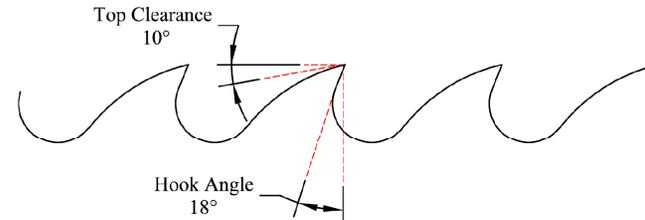

### Aluminum, Copper - Non-Ferrous

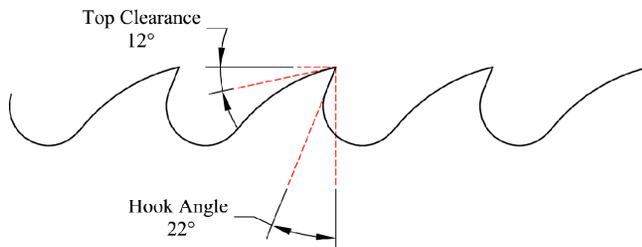

### Stainless Steel and some Tool Steels

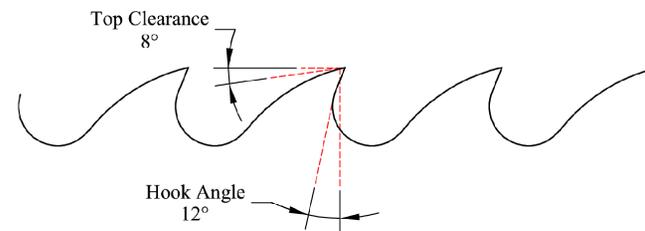

**16° - 18° Hook Angle is Standard and is often referred to as "Rake" or Rake Angle"**

# PROPER PITCH AND COLD SAW BLADE SELECTION

## SOLID - Slower RPM & 3-5 Teeth in the Material

Rounds usually cut better with closer to 5 teeth in the material

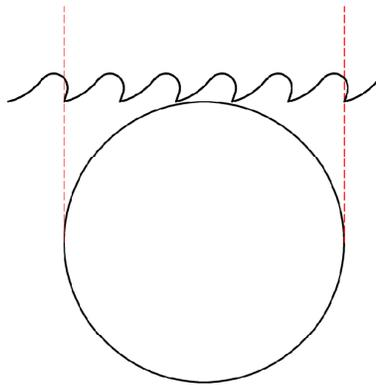

Squares usually cut better with closer to 3 teeth in the material

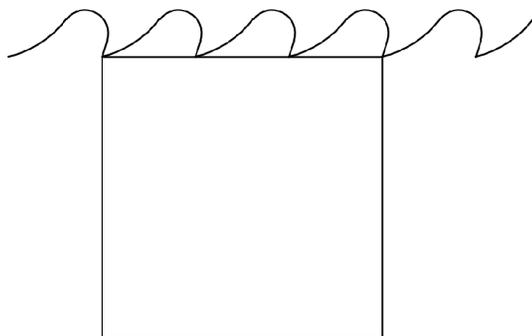

## TUBE - Thick Walled

Slower RPM & Pitch should be Less than the Wall Thickness.

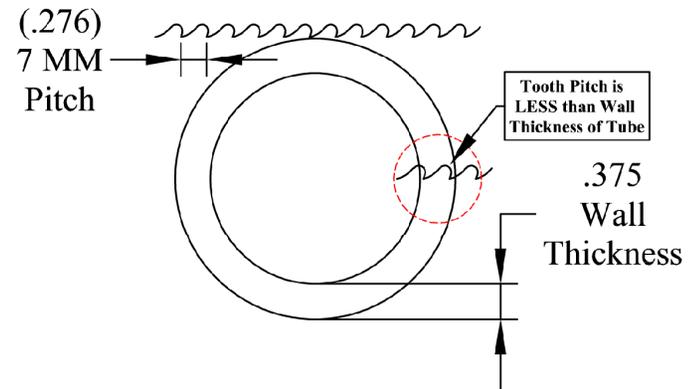

## TUBE - Thin Walled

Higher RPM & Pitch should be as small as Practical. 3 - 3.5 mm (.118 - .138) is the Smallest Pitch Available.

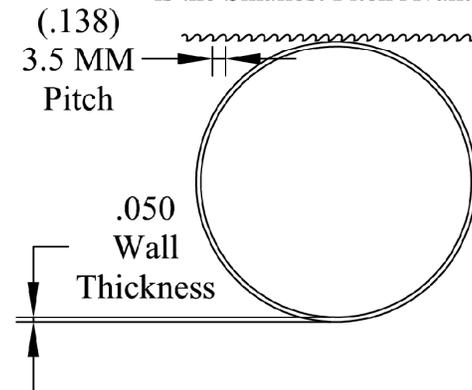

# TYPES OF BEVELS AND NOTCHES AND WHERE USED

## ALTERNATE

Teeth are the same Height.  
All the Teeth have a Bevel.  
Every Other Tooth is Beveled  
on Every Other Side. Used on  
Blades with a 4.5 Pitch or Less,  
Generally, 220 Teeth or more.  
More Teeth = Smaller Pitch  
Used on thinner walled Tube &  
Angle and Small Solids.

## TRIPLE CHIP

Every other Tooth is Taller.  
Often said to have a "High-Low"  
The High-Tooth has a Bevel on Both  
Sides. The Low Tooth has  
NO Bevel at all. Hi-Tooth cuts the  
Middle out and Low tooth is the  
Tooth that leaves Finish on the Cut  
Part. Generally used on Blades  
with a 4.5 Pitch or more.  
Less Teeth = Larger Pitch.  
Best for Solids and Thick Wall Tube.

## NOTCH GRIND

Teeth are the same Height.  
All the Teeth have a Notch.  
Notches are Offset from Each  
Other and breaks up the Chip  
made during the Cut. Typically  
used on Blades with a 4.5 Pitch or  
Less, Generally, 220 Teeth or more.  
More Teeth = Smaller Pitch  
Best for thinner walled Tube &  
Blade RPM should be increased.

## ROUND GRIND

Teeth are the same Height.  
There is No Bevel. Typically used  
on Blades with a 3.5 Pitch or Less,  
as Teeth this small are extremely  
difficult to bevel. This works best  
for thinner walled Tube .  
Also used for soft materials such as  
Nylon, Plastic, PVC, etc. in most  
any shape or size and with  
whatever tooth size works the best.

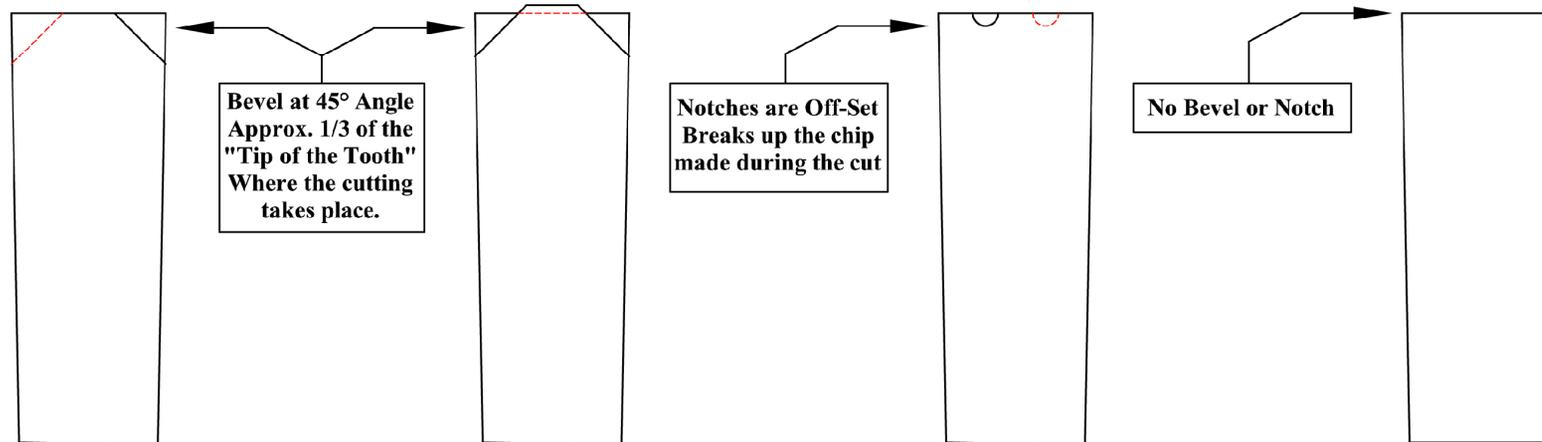

**Triple Chip and Alternate Grinds are by far the most common.  
Power 2000 Blades have the Notch Grind & Titanium Coating.**

Scotchman Ind. 180 E US Hwy 14 - Philip, SD 57567 USA  
P 605.859.2542 - F 605.859.2499 - [www.scotchman.com](http://www.scotchman.com) - [info@scotchman.com](mailto:info@scotchman.com)

## Saw Blade Size, # of Teeth & Pitch

**Pitch** is the size of one saw blade tooth, OR the distance from one tip to the next in millimeters.

More teeth = a smaller pitch (14" 220 has a 5.0mm Pitch)

Less teeth = a larger pitch (14" 150 has a 7.5mm Pitch)

Below, on the right we have a chart that shows the selection of the proper saw blade for the material being cut. On the left is a chart for Round Tubing, Angle Iron, and Square Tube cut on the Diagonal.

For cutting Square Tube across the flat you should increase the pitch by 1mm to 2mm. For example, if you cut a Mild Steel 2" round .187" (3/16) wall tube or a 2" square. 187" (3/16) tube on the diagonal (point-to-point) with a 14" diameter blade, a 180-tooth blade is used and has a 6.5mm pitch.

The same 2" square .187" (3/16) walled tube cut across the flat needs a blade with a 7.5mm to 8.5mm pitch (less teeth). The chart shows a 14" 150 tooth blade has a 7.5 pitch and that should work just fine.

***Remember: There is no general purpose or "Universal" Cold Saw Blade. The proper blade must be used for the material being cut.***

### Round Tubing - Angle & Square Cut on the Diagonal

Square Tube Cut Across the Flat - Increase Pitch 1mm - 2mm (less teeth)

MATERIAL	BLADE SIZE, # OF TEETH & PITCH			
Wall Thickness	275mm 10-3/4"	315mm 12-1/2"	350mm 14"	Pitch
.030 - .060	260 Teeth	280 Teeth	320 Teeth	3.5mm
.060 - .090	200 Teeth	220 Teeth	250 Teeth	4.0mm
.090 - .150	160 Teeth	180 Teeth	200 Teeth	5.5mm
.150 - .250	<b>For Thick-Walled Tube, Please Call Our Factory for a Recommendation</b>			
.250 - .375				
.375 - .500				

### Round & Square Solid Bar

Tough Alloys or Stainless - Decrease Pitch (more teeth) 1mm - 2mm

Aluminum & Copper - Increase Pitch (less teeth) 1mm - 2mm

MATERIAL	BLADE SIZE, # OF TEETH & PITCH			
Solid Bar	275mm 10-3/4"	315mm 12-1/2"	350mm 14"	Pitch
1/2 in.	200 Teeth	220 Teeth	250 Teeth	3.5mm
5/8 in.	160 Teeth	180 Teeth	200 Teeth	4.0mm
3/4 in.	140 Teeth	150 Teeth	180 Teeth	5.0mm
1 in.	120 Teeth	140 Teeth	150 Teeth	6.5mm
1-1/4	110 Teeth	120 Teeth	140 Teeth	8.0mm
1-1/2	100 Teeth	110 Teeth	130 Teeth	8.5mm
1-3/4	90 Teeth	100 Teeth	120 Teeth	9.5mm
2 in.	80 Teeth	90 Teeth	100 Teeth	11mm

# THINGS TO REMEMBER WHEN CHANGING BLADES

These are simple, yet critical practices to follow every time a blade is changed.

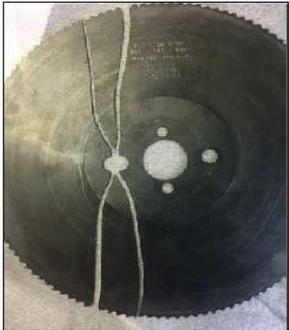

## BACKLASH

The saw blade is driven by the pins in the flange. When changing blades, the Backlash must be removed or "Taken-Up" and is very simple to do. When the blade is put on the machine, but before the bolt on the flange is final-tightened, lift up on the front of the blade and hold it there until the bolt is tight. This

keeps the pin-holes in and the blade against the pins in the flange. If a blade breaks through a pin-hole, it is because the Backlash was not removed, see the "Backlash" example picture to the left.



## DIRTY FLANGE

A Dirty Flange happens when a saw blade is changed, but metal chips were allowed in between the Flange and/or saw spindle when the blade was mounted. It's like bolting a wheel onto a hub and putting a rock in between them before tightening the wheel to the hub. This will cause the saw blade to "wobble" and appear to have excessive run-out. A saw blade cannot run true and cut properly with a Dirty Flange, and it can contribute to many other saw blade problems, especially Pick-Up.

In this "Dirty Flange" picture above, you can see the circled "shiny spots" are where metal chips were in between the spindle and the blade which wore away the black oxide coating.

*A clean flange is very important!!!*



## PICK-UP

*What causes Pick-Up?* Many things: A Dirty Flange...Using a dull blade ...Weak or wrong coolant...Using the wrong blade...Using the wrong rpm...Too much down-pressure.

Pick-up is where the material being cut has bonded itself to both sides of a tooth making it wider or thicker than the saw blade. Every time that thicker tooth passes through the material it will grab the material and cause the saw head to jump, generally with a loud sound, "clunk – clunk – clunk." The pick-up will get worse each time it passes through the material. Many will often think the saw blade is "out-of-

round" because of the way it feels during the cut. At some point, the pick-up will jam the blade in the material and either rip a chunk out of the blade or break the blade into several pieces. Pick-up can also cause the material to move during the cut, either the material will roll or move, forcing the blade off to one side, and shattering it. Pick-Up can be felt by dragging a finger-nail over the side of the tooth. If you feel pick-up on the blade **STOP** using it or you risk a broken blade.

When caught early, pick-up, is best removed by smoothing it off with a **hand-held** hone-stone - NOT with a power tool!! If you take too much off, then you make the blade thinner in that spot, which is not good either. NOTE: most often you will get pick-up again in the same place as the finish on the blade has been compromised. The best way to get rid of pick-up is to have the blade re-sharpened.

## MATERIAL SLIPPING IN

### WISE



The material must be properly seated and solidly clamped in the vise. If the material moves

during the cut it can bend or break the saw blade. Pick-Up can be a major contributor.

Evidence of this is an unusual rub mark typically on one side of the blade.

## 3 Things to Prolong the Life of Your Saw Blades

### **BREAKING IN THE BLADE**

When a new or re-sharpened blade is mounted, it has very sharp edges and needs to be fed slowly through the material for the first 3-4 cuts. This helps to extend blade life.

### **COOLANT**

It is vital to use a good coolant mixed to the proper strength. Weak coolant will shorten blade life and can cause Pick-Up. Rust indicates weak coolant and can cause problems, as well as ruin saw blades (by damaging the blade coating) and parts of the saw. Scotchman Synthetic Sawing Coolant is available for mild steel and stainless steel.

### **Saw Blade Diameter**

The smaller the blade is, the more rigid it is. Also, the SFM (Surface Feet per Minute) or "Rim Speed" is less with a smaller blade. Smaller blades are less expensive to purchase and sharpen as well.

**Read the Operators Manual**  
**All operators should read and understand the operator's manual. Important safety tips and maintenance information about your saw is contained in this document.**



## **Scotchman COLD SAW MODELS**

Scotchman has a full line of circular Cold Saws models available with many options, manual to fully automatic.

Contact our customer service department to let us help you decide which saw will best fit your business. 1.800.843.8844

OR

Visit our website [www.scotchman.com](http://www.scotchman.com).

Scotchman Ind. 180 E US Hwy 14 - Philip, SD 57567 USA

P 605.859.2542 - F 605.859.2499 - [www.scotchman.com](http://www.scotchman.com) - [info@scotchman.com](mailto:info@scotchman.com)

